



GREAT LAKES

MILLWORK AND HARDWOOD LUMBER

SPECIALTY WOOD PRODUCTS

Architectural Millwork • Standard and Custom Profiles

Custom Millwork Packages in any profile and any wood species

Hardwood Lumber • S4S Boards • Interior Doors

Stair Trends • Stair Parts

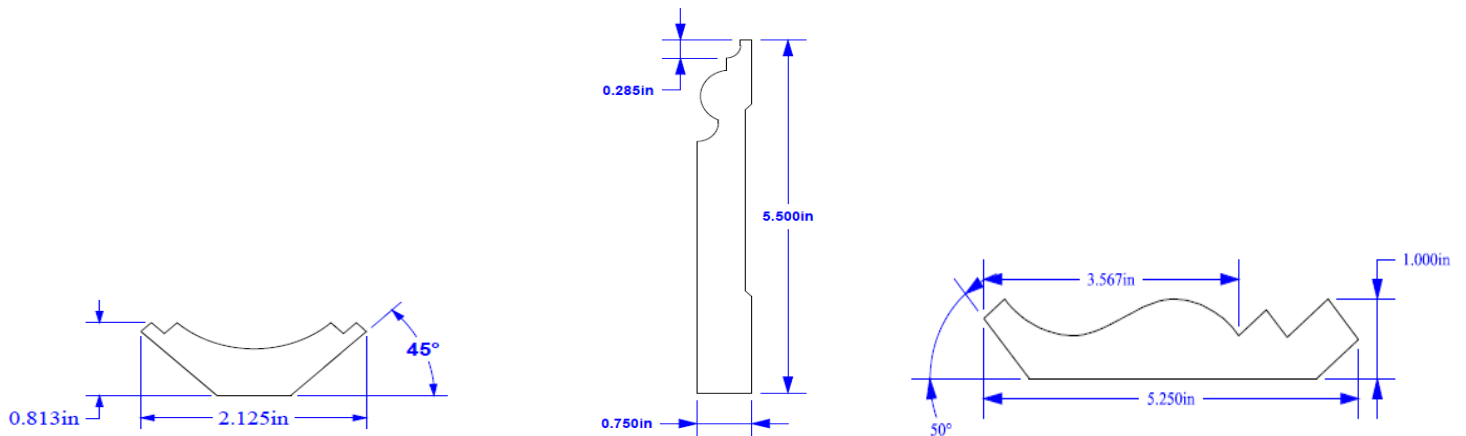

Paul Carruth

612-910-0246

1935 Bayard Avenue • Saint Paul, MN 55116

INDEX

- AP** Applied Mouldings ... *pages 1-3*
- B** Back Band ... *pages 4-6*
- BA** Baseboard ... *pages 7-14*
- BC** Base Cap ... *pages 15-20*
- CA** Casing ... *pages 21-40*
- CH** Chair Rail ... *pages 41-43*
- CR** Crown & Bed Mouldings & Inside Corners ... *pages 44-55*
- HR** Hand Rail ... *pages 56-59*
- MS** Miscellaneous Mouldings... *pages 60-77*
- PL** Tongue & Groove Paneling, Beaded Ceiling ... *page 78*
- S** Window Sills & Stools ... *page 79*
- Transitional Mouldings... *page 80*

Some Patterns can be changed in thickness and width.

If you don't see it here, we can reproduce any patterns you may have.

AP1501

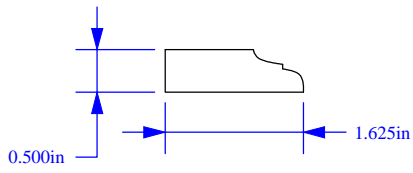

AP1502

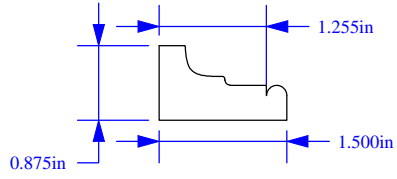

AP1503

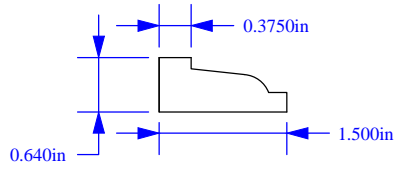

AP1751

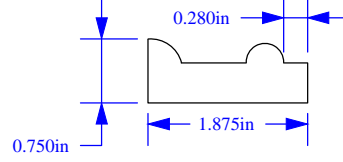

AP1752

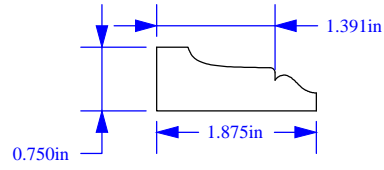

AP2001

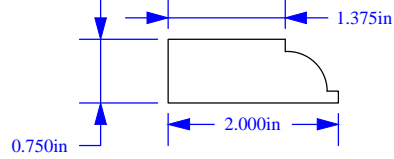

AP2002

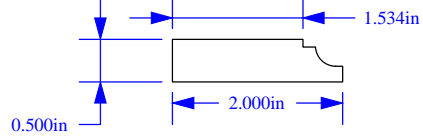

AP2003

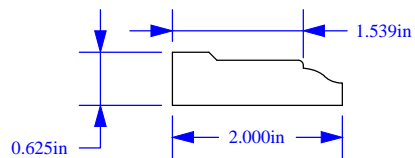

AP2251

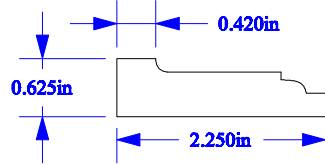

AP2258

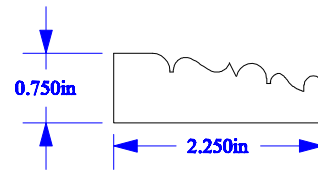

AP2252

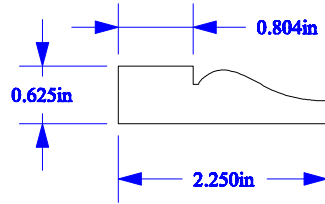

AP2253

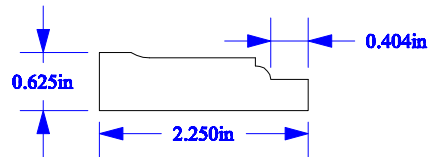

AP2254

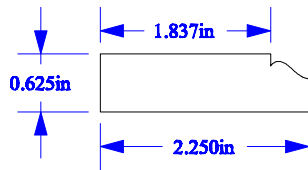

AP2255

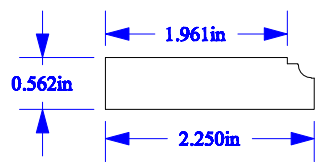

AP2256

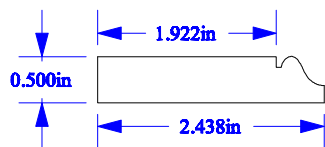

AP2257

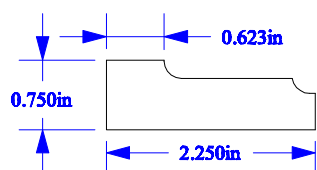

AP3001

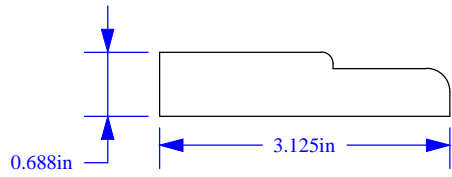

AP3251

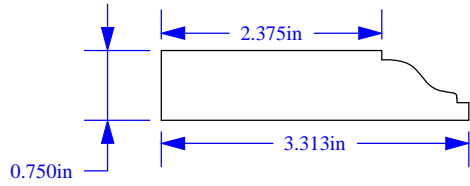

AP3252

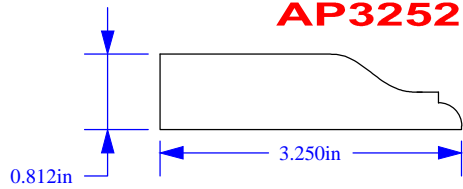

AP3253

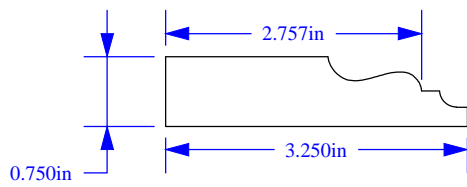

AP3254

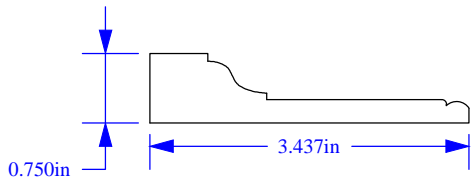

AP3255

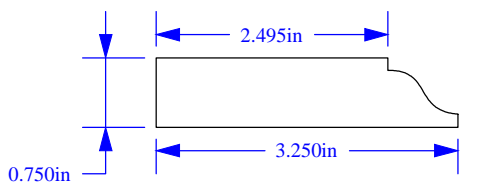

AP3501

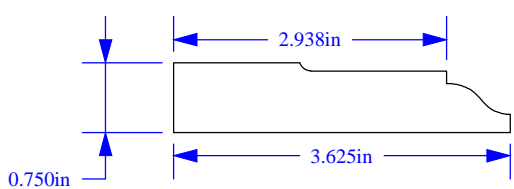

AP3502

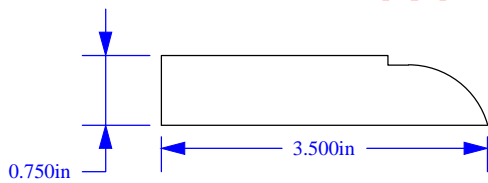

AP3503

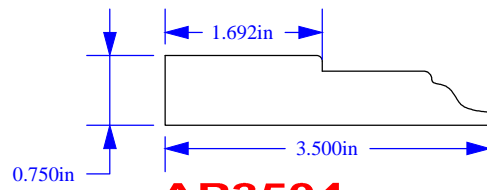

AP3504

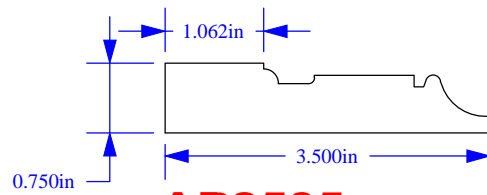

AP3505

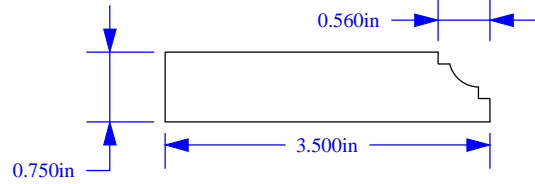

AP3506

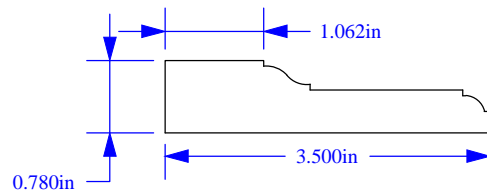

AP4001

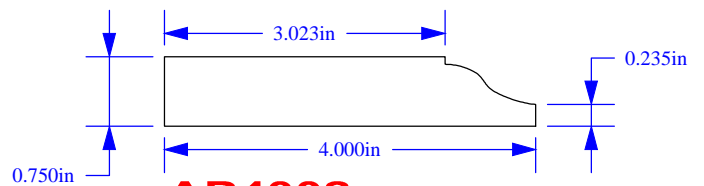

AP4002

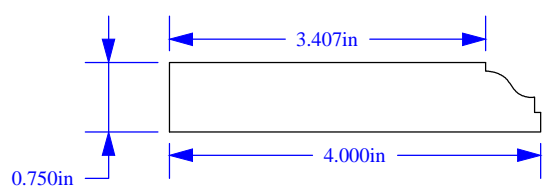

AP4251

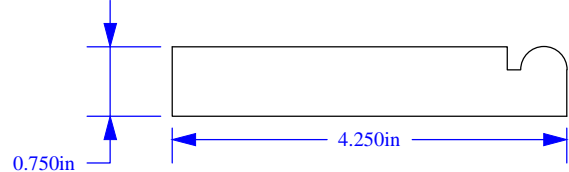

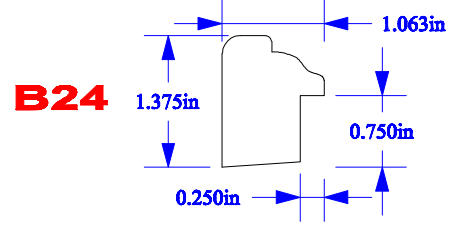
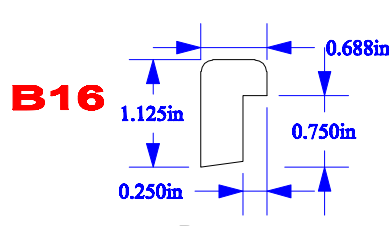
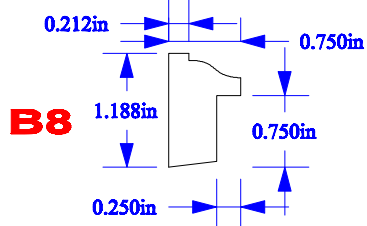
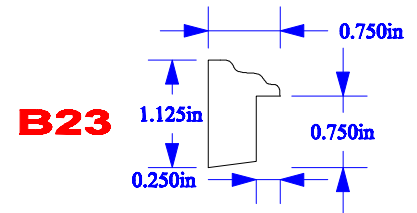
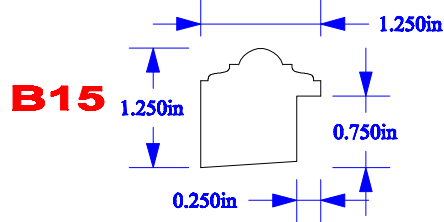
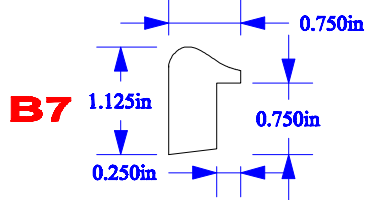
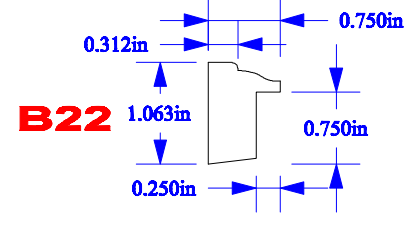
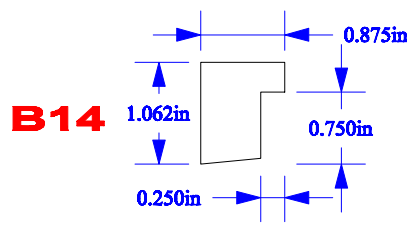
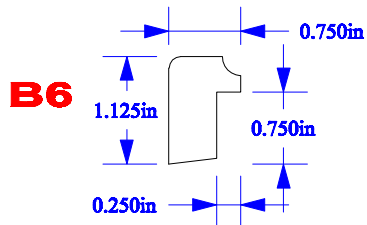
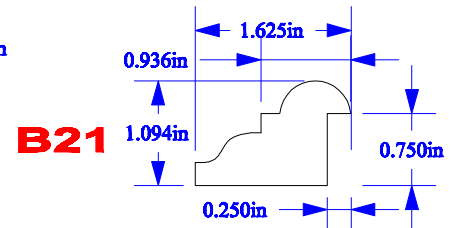
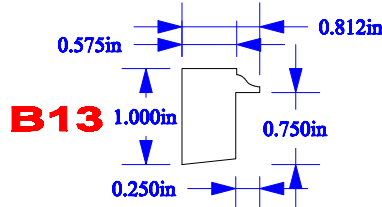
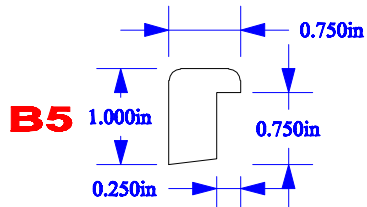
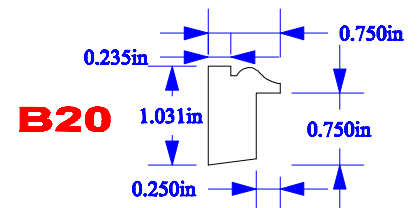
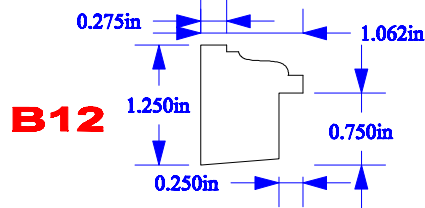
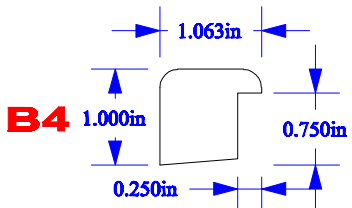
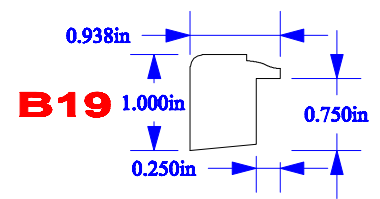
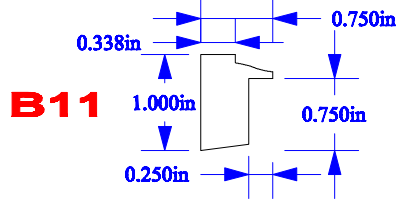
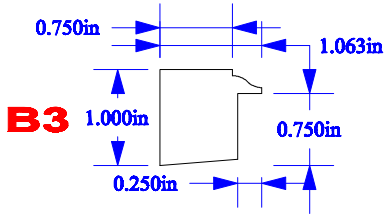
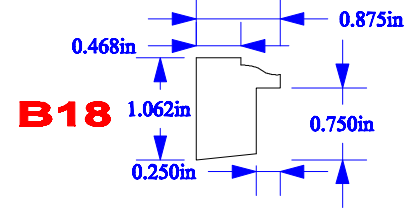
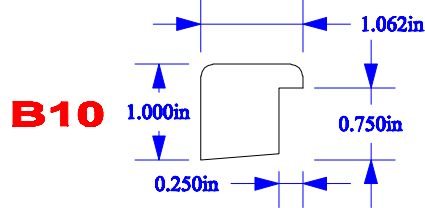
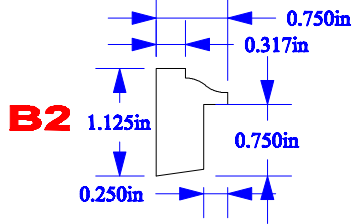
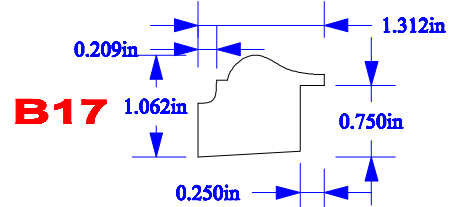
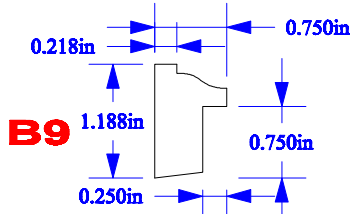
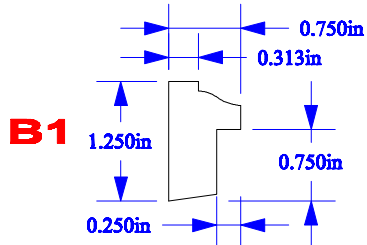

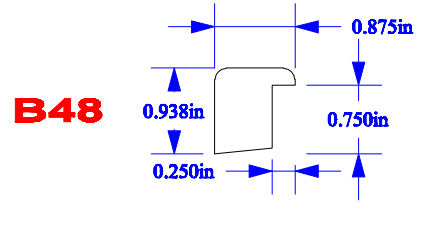
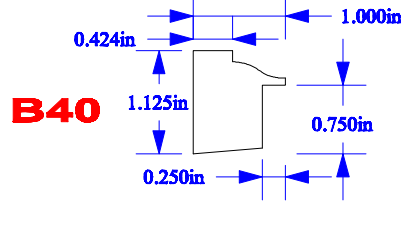
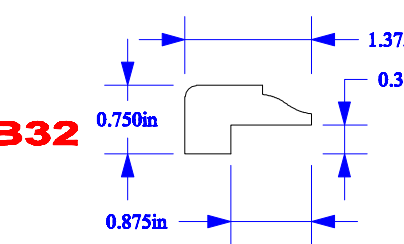
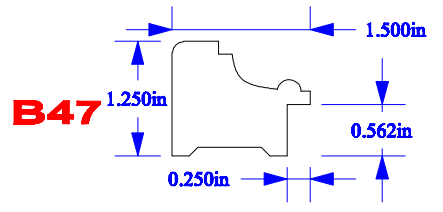
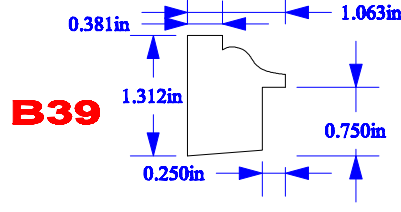
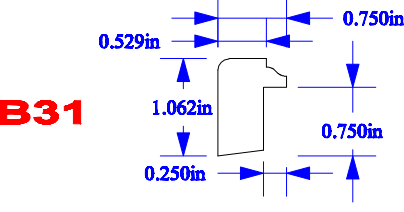
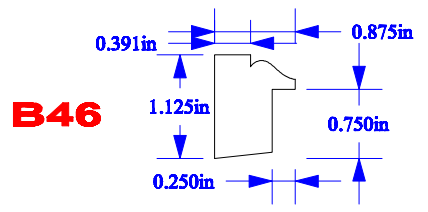
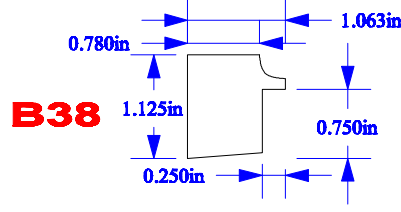
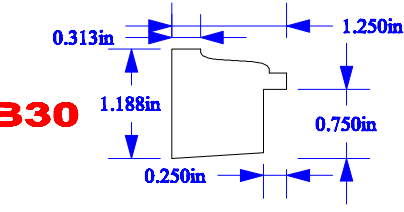
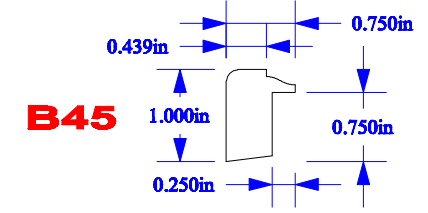
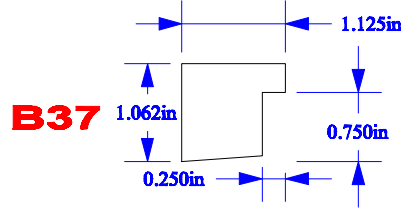
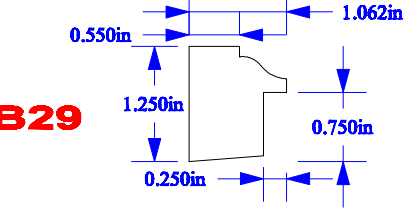
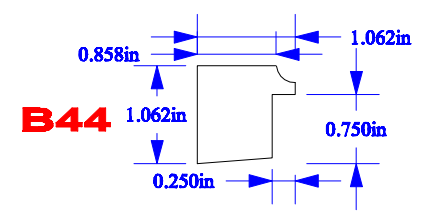
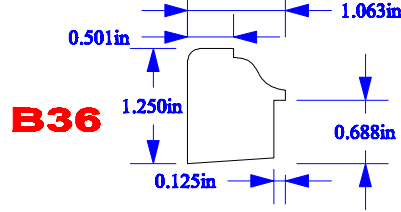
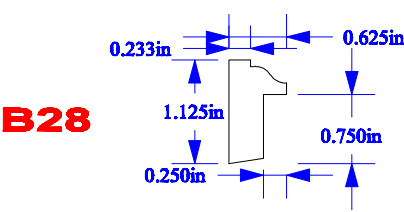
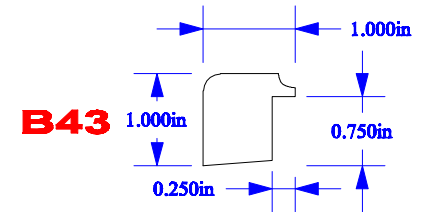
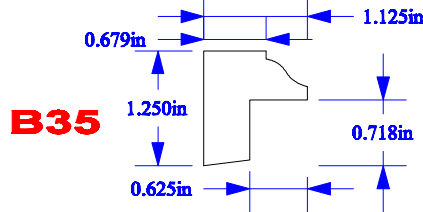
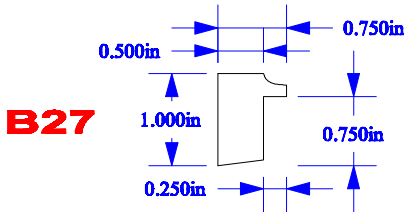
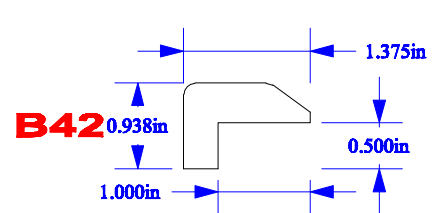
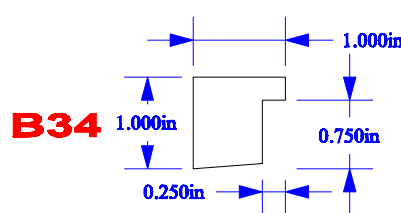
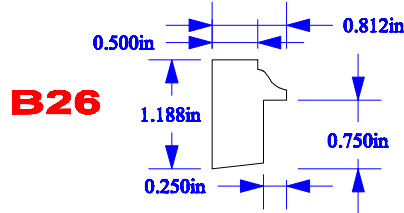
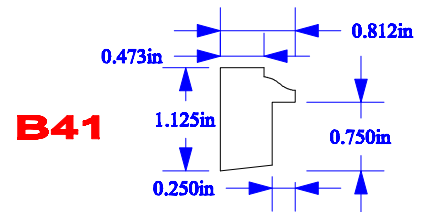
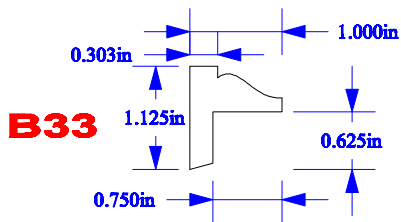
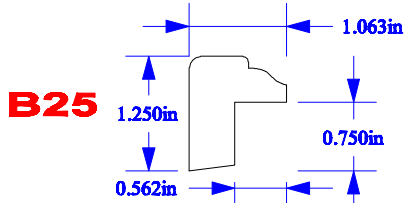

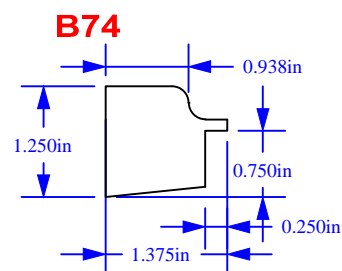
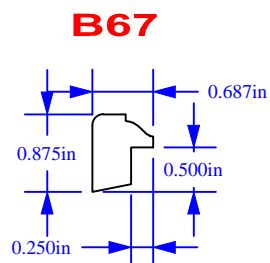
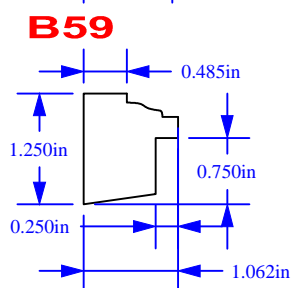
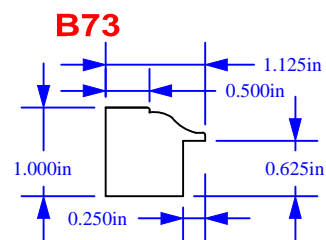
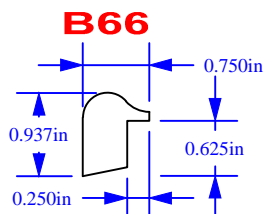
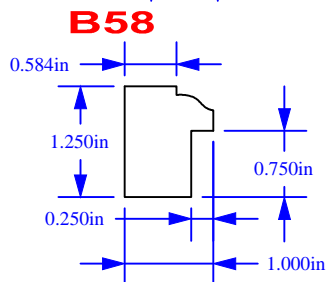
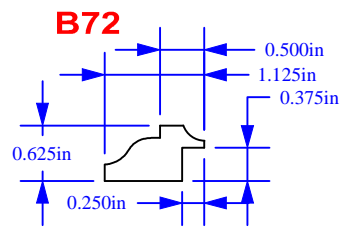
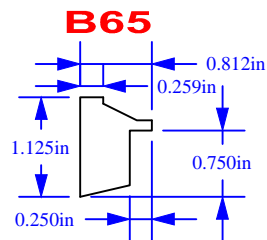
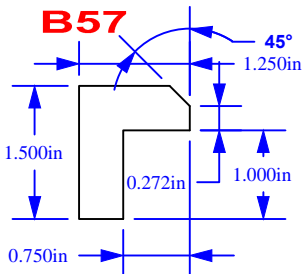
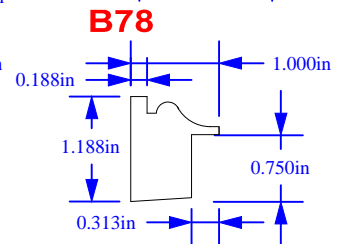
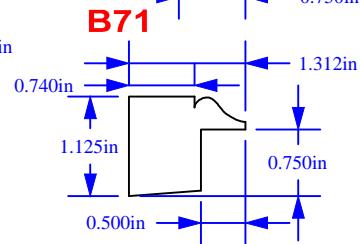
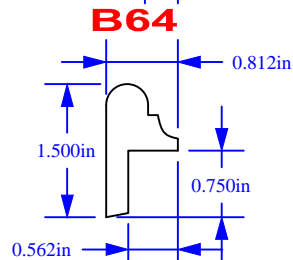
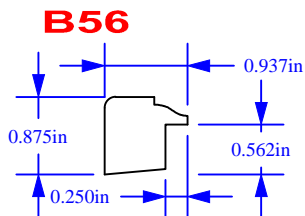
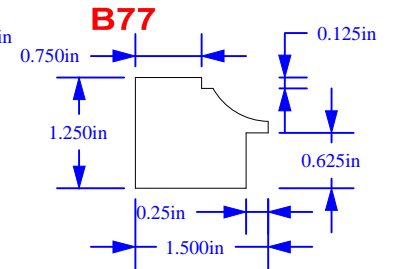
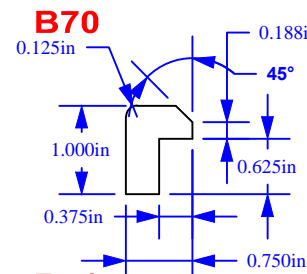
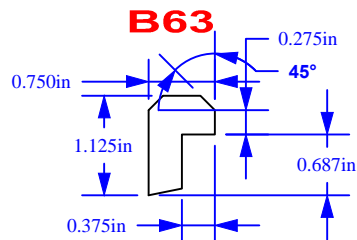
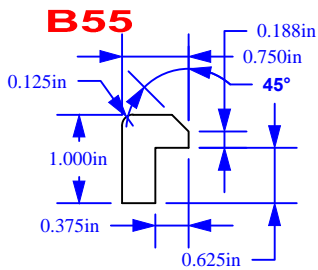
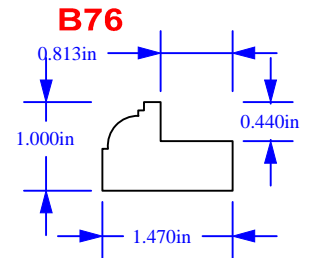
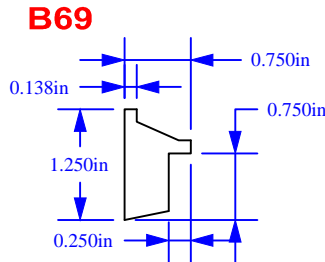
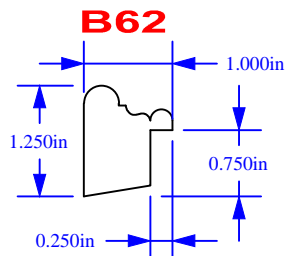
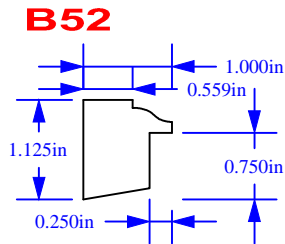
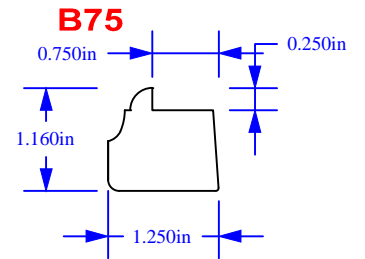
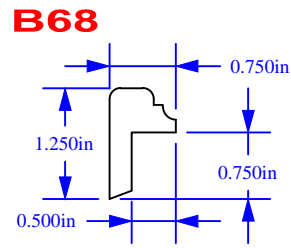
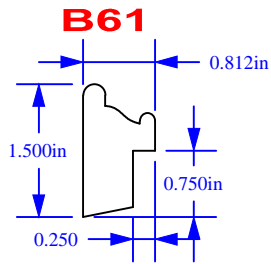
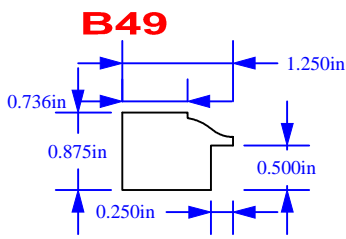

BA2501

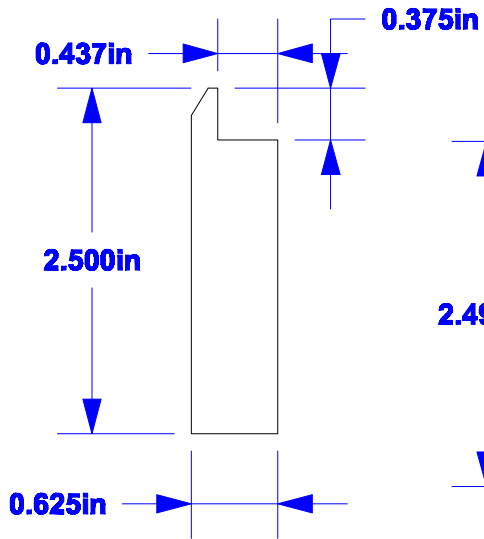

BA2502

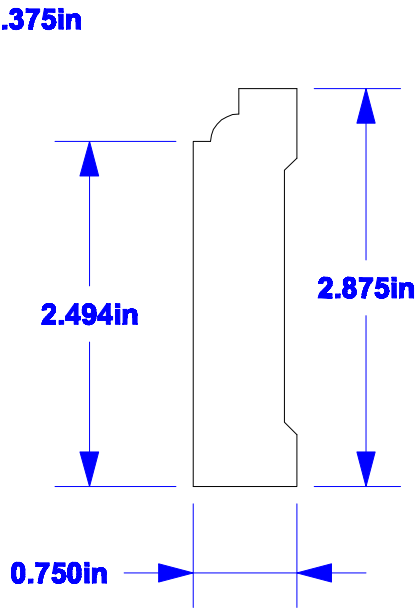

BA2503

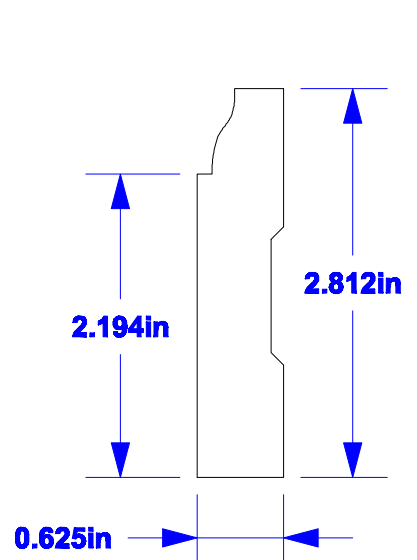

BA3001

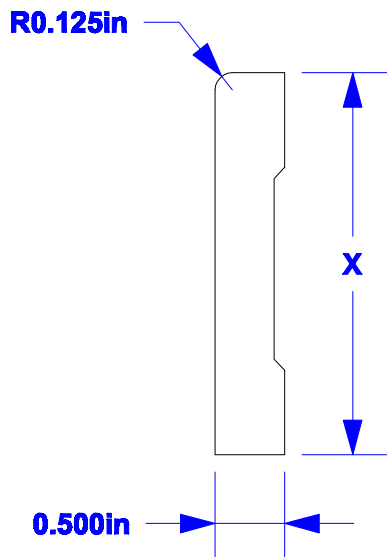

BA3002

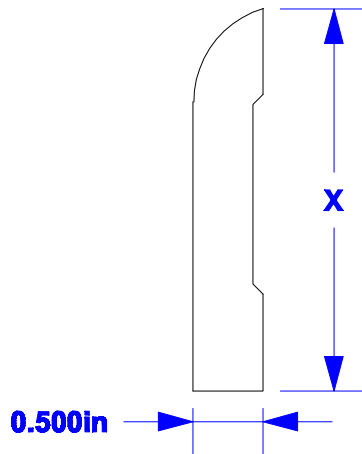

BA3003

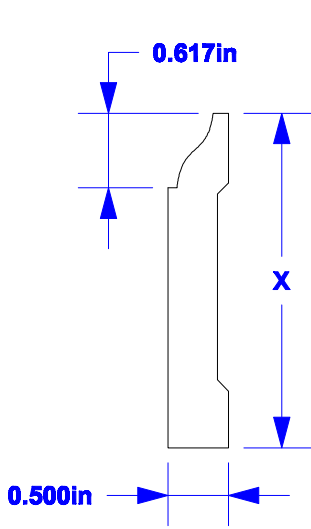

BA3004

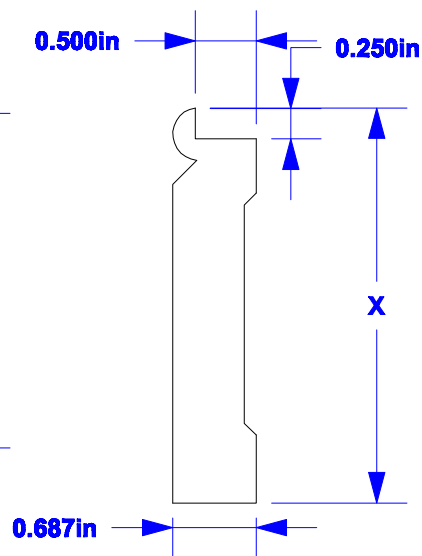

BA3005

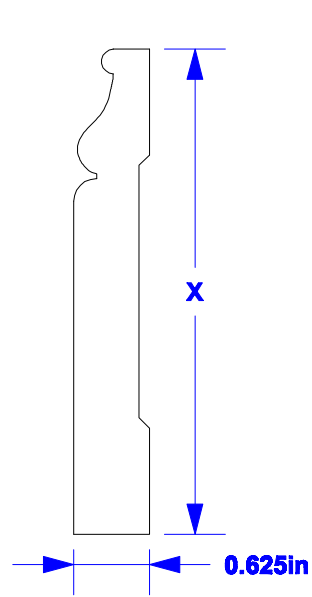

BA3006

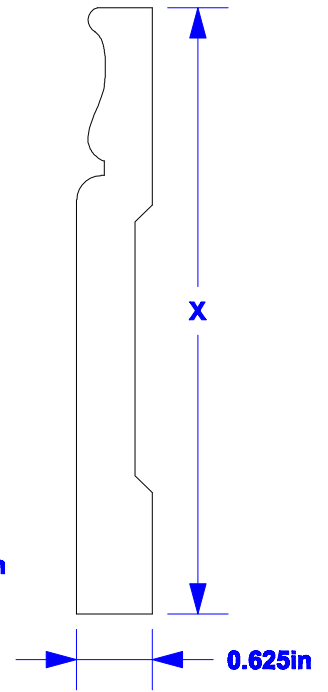

BA3007

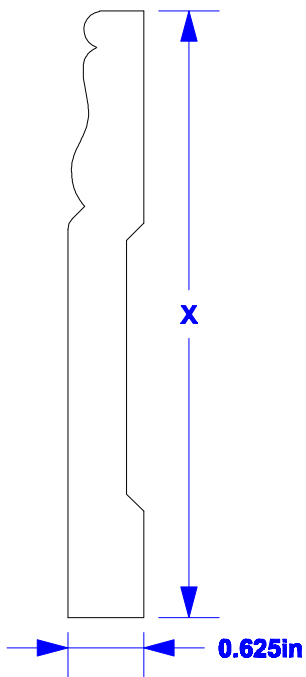

BA3008

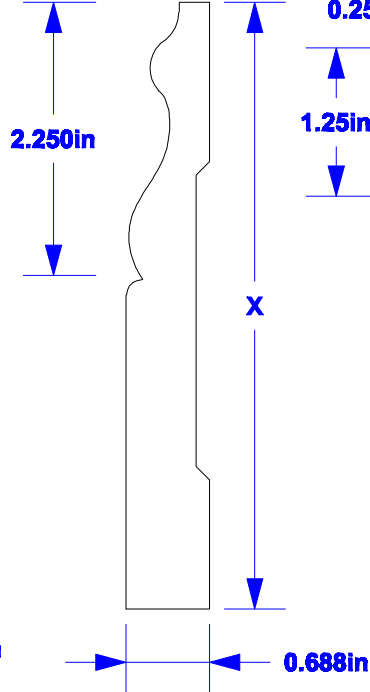

BA3009

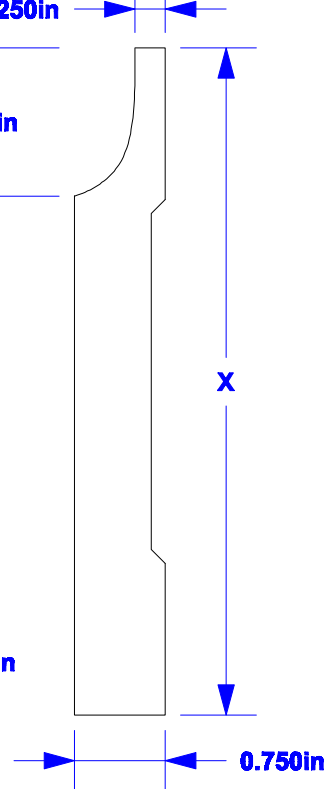

BA3010

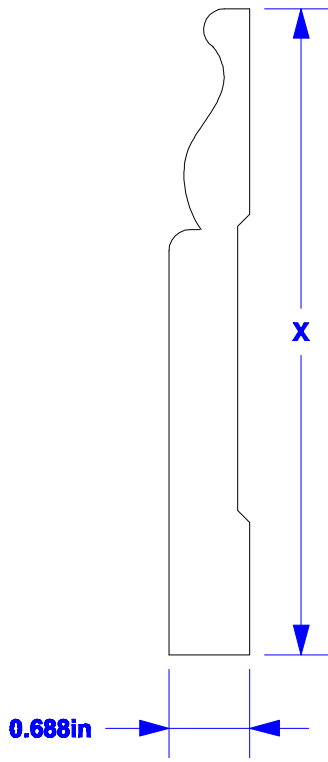

BA3011

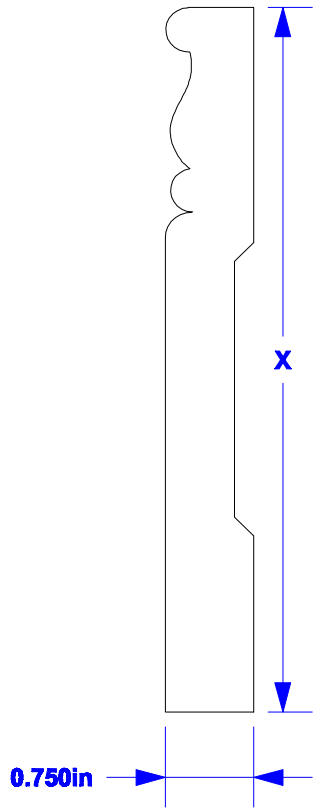

BA3012

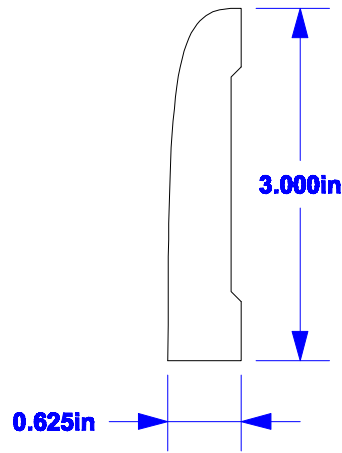

B3014

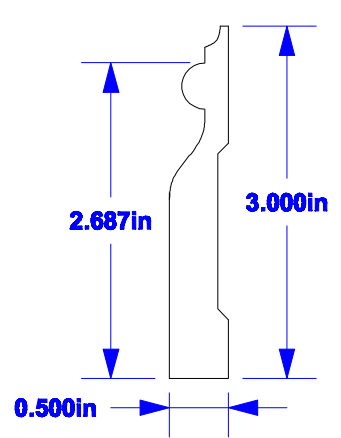

BA3251

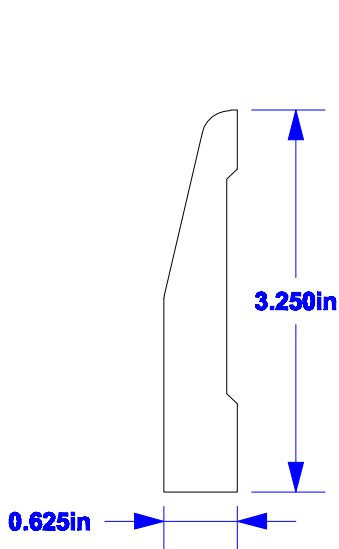

BA3252

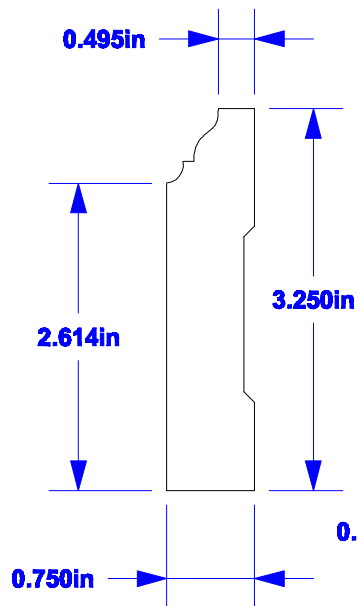

BA3253

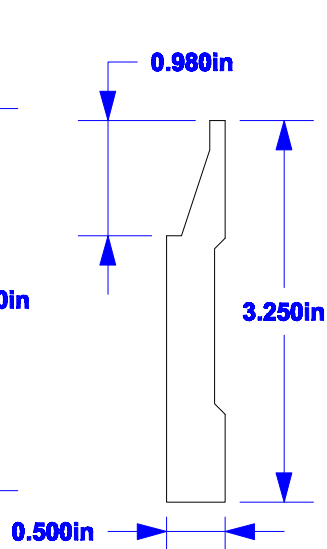

BA3501

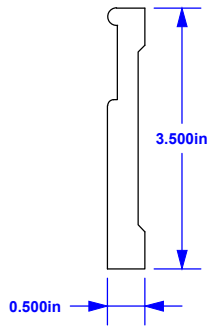

BA3502

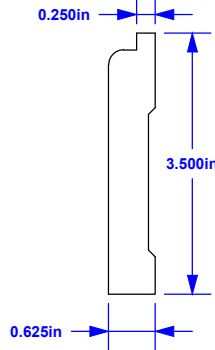

BA3503

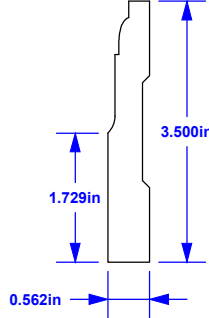

BA4000

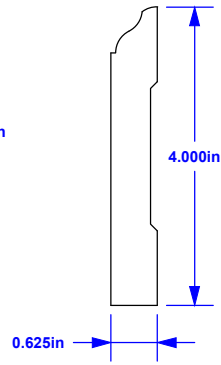

BA4002

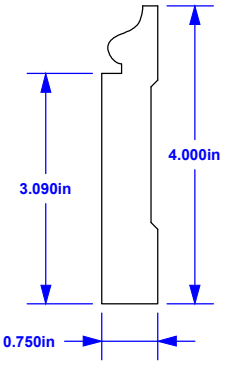

BA4003

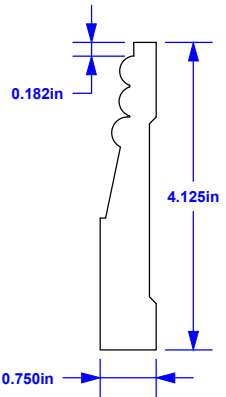

BA4004

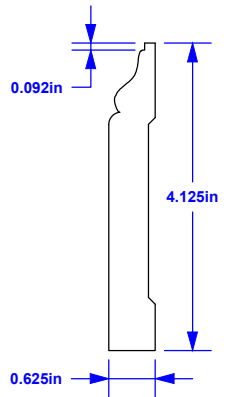

BA4005

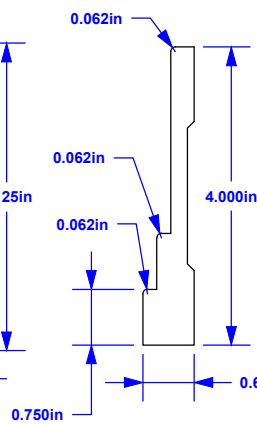

BA4251

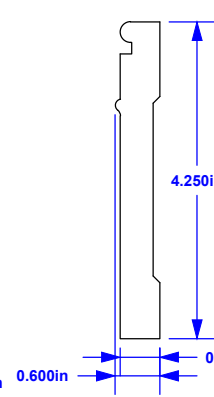

BA4252

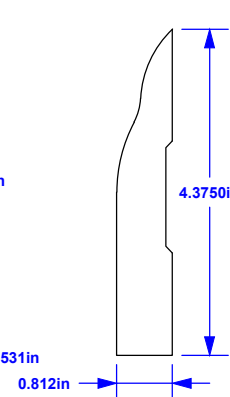

BA4253

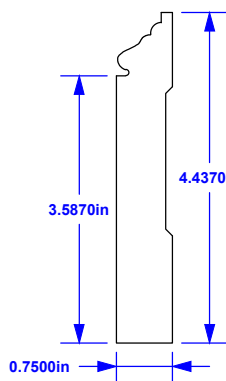

BA4254

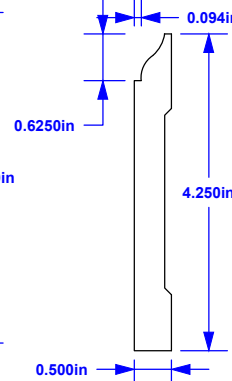

BA4255

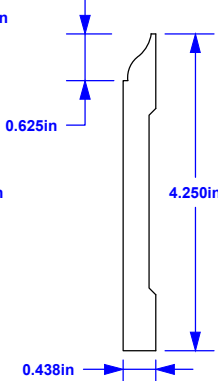

BA4501

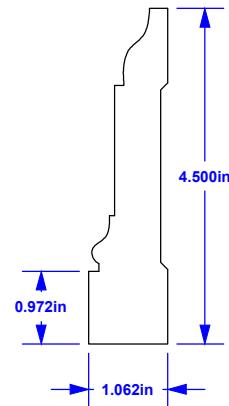

BA4502

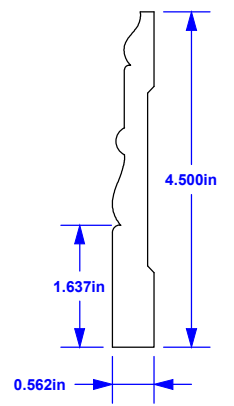

BA4503

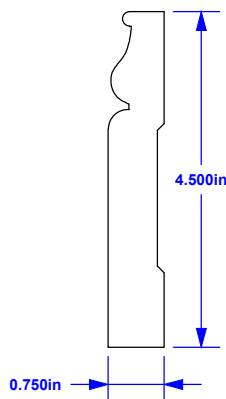

BA4504

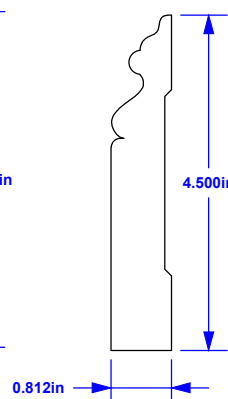

BA4505

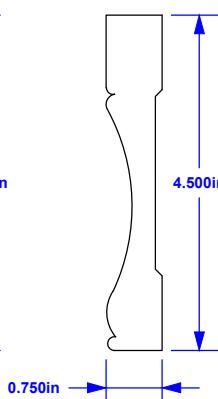

BA4506

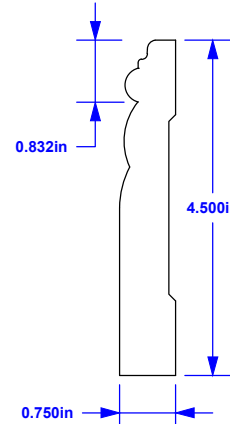

BA4751

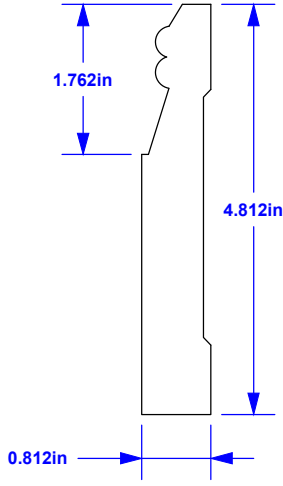

BA4752

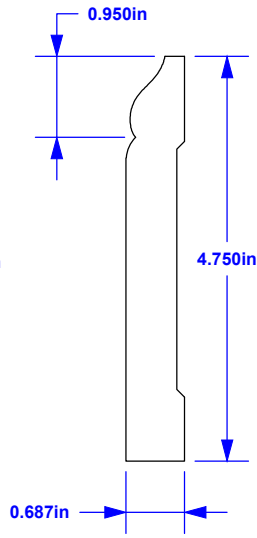

BA5001

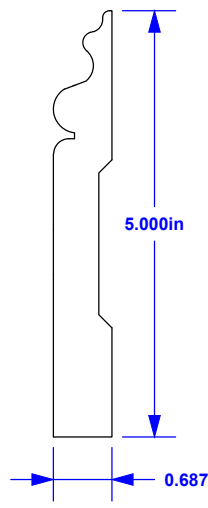

BA5002

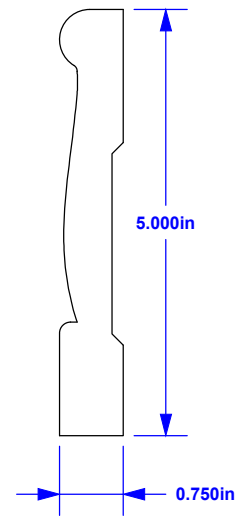

BA5004

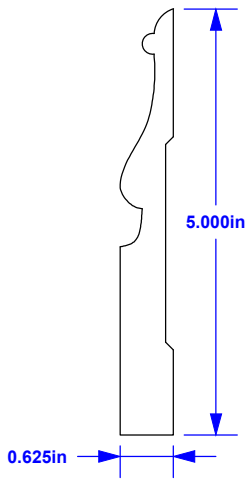

BA5006

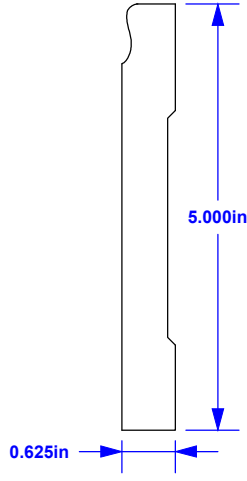

BA5007

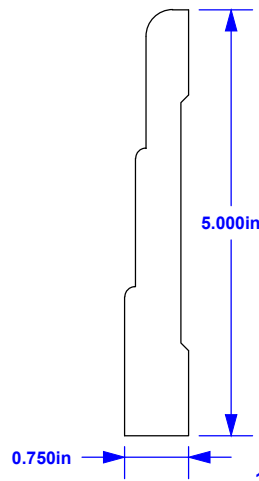

BA5008

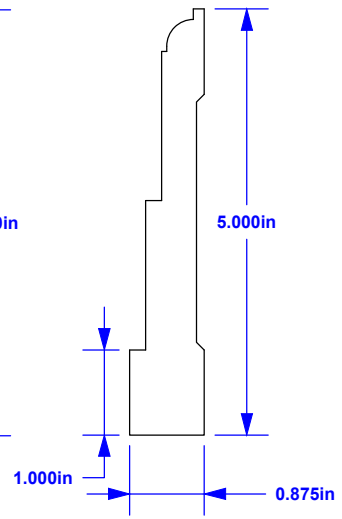

BA5010

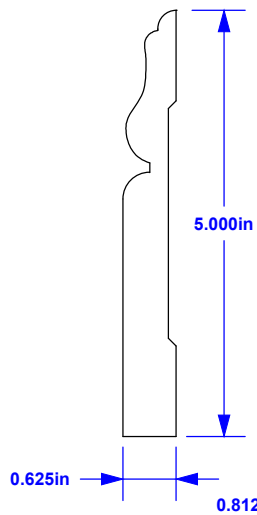

BA5011

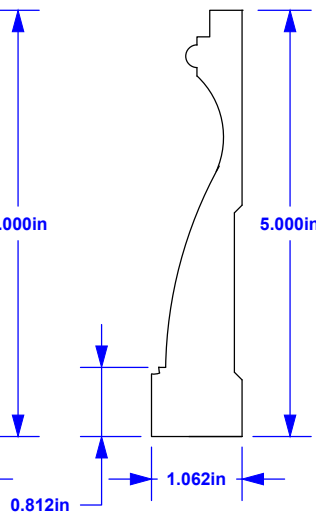

BA5012

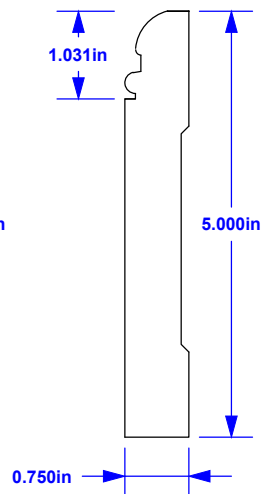

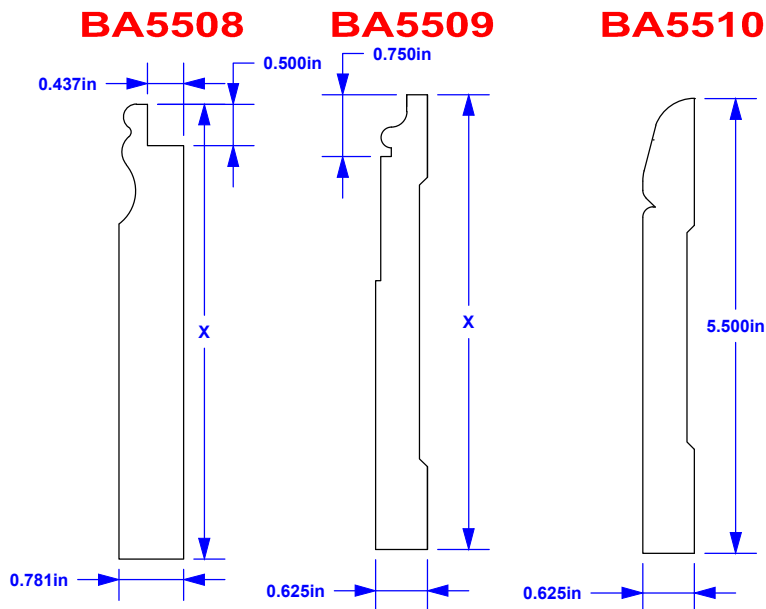
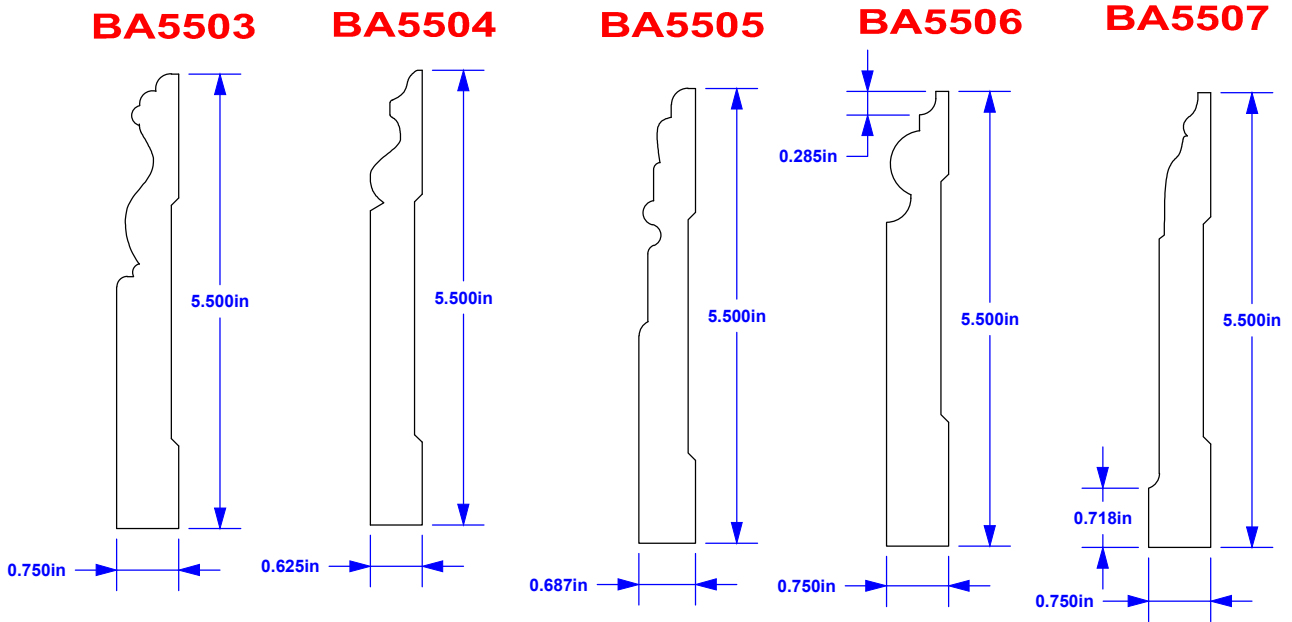
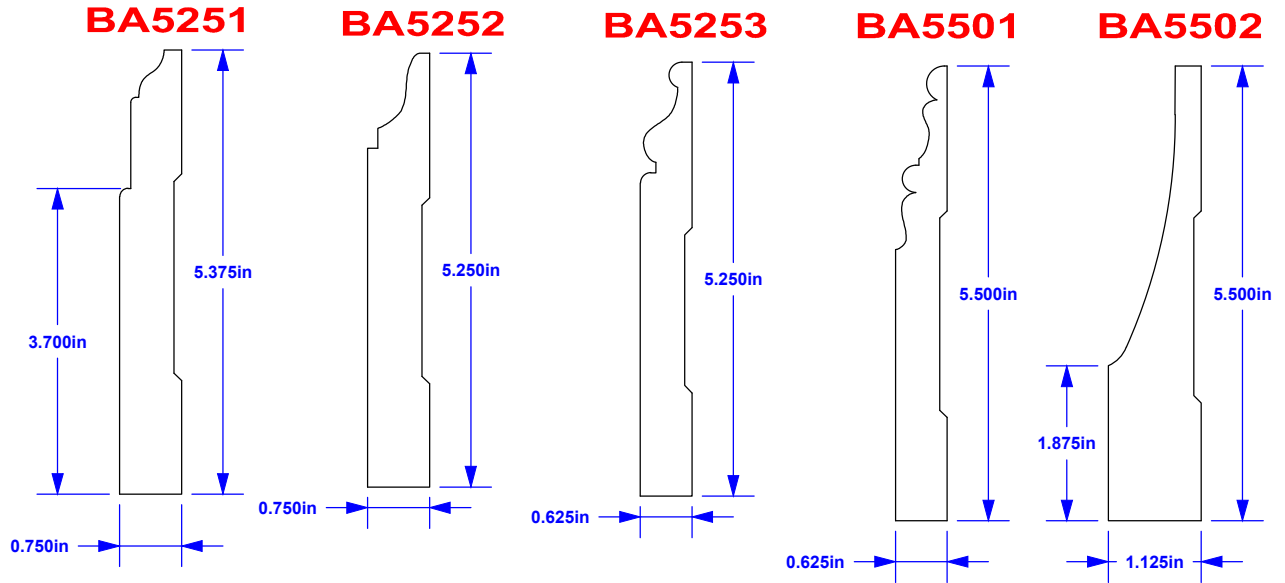

BA6001

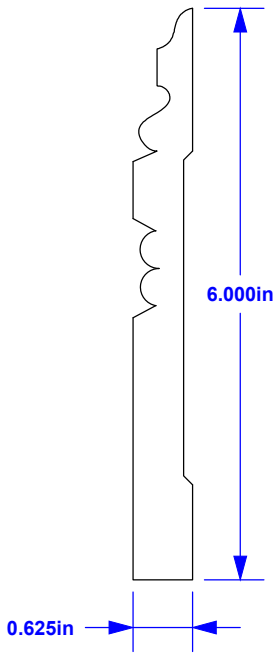

BA6002

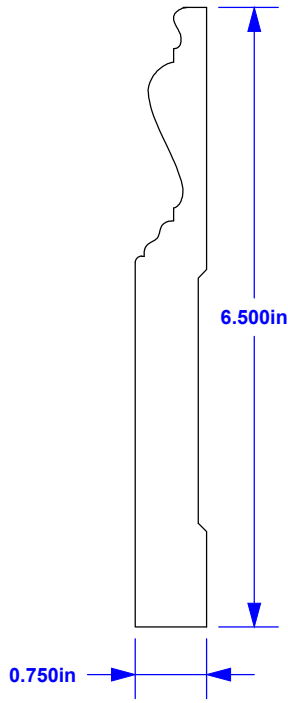

BA6003

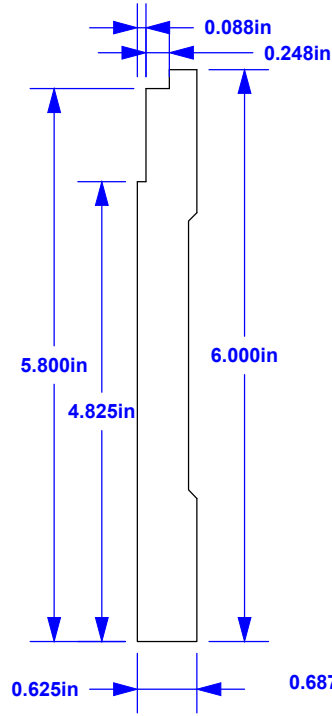

BA6004

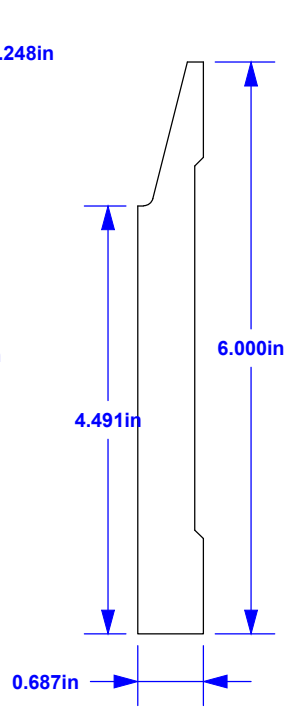

BA6005

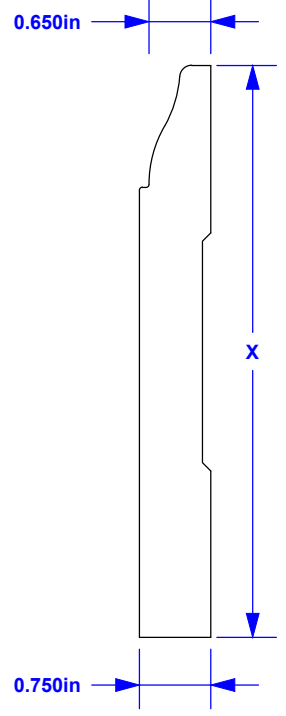

BA6006

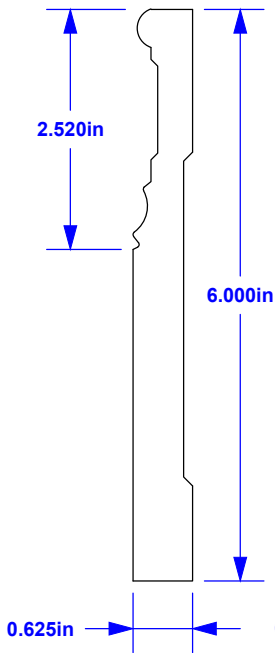

BA6250

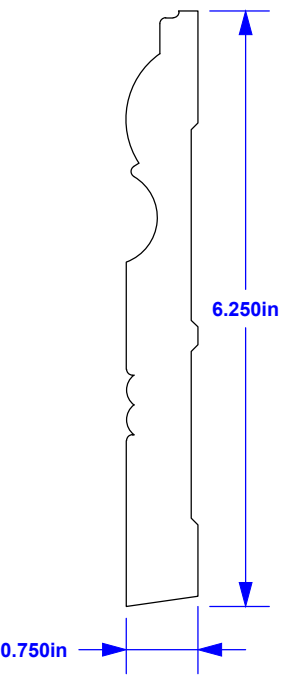

BA6501

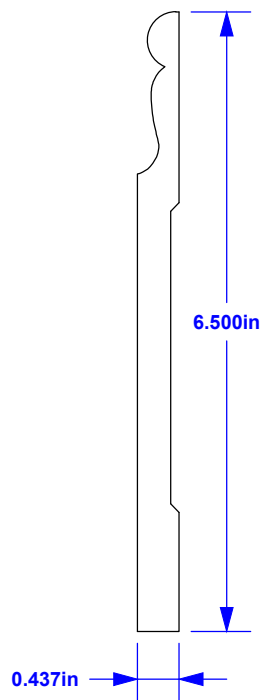

BA6502

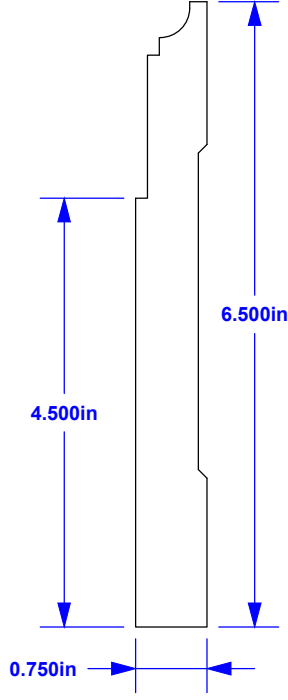

BA6503

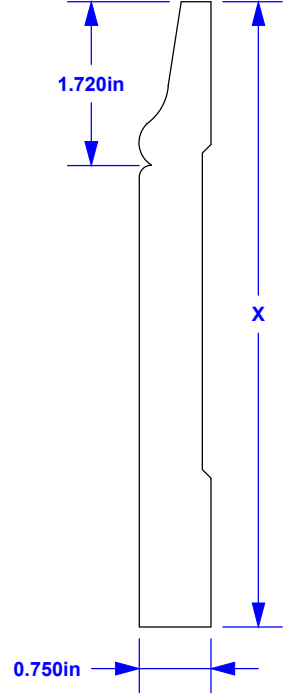

BA6751

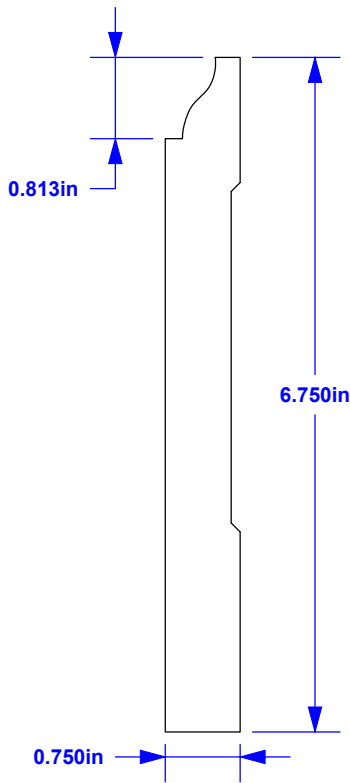

BA7001

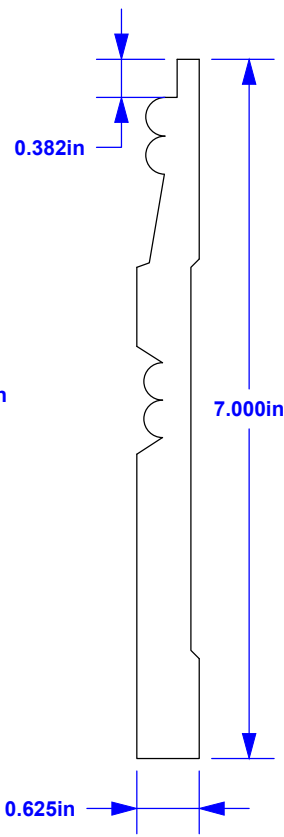

BA7251

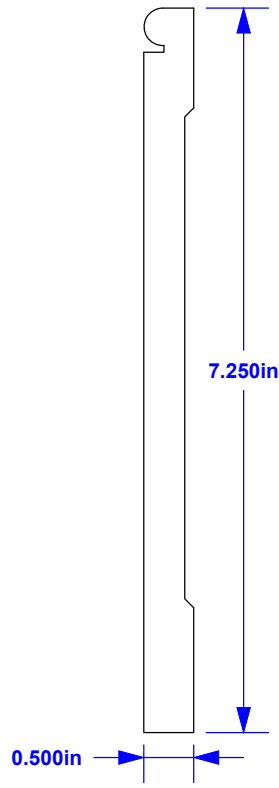

BA7252

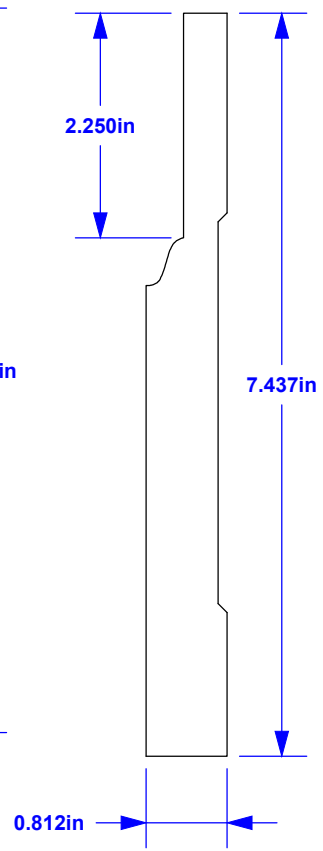

BC0751

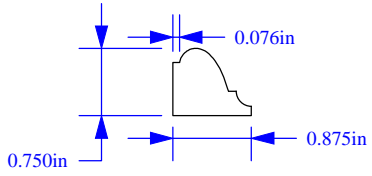

BC0758

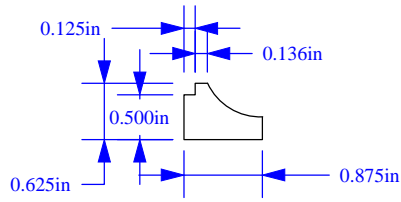

BC1012

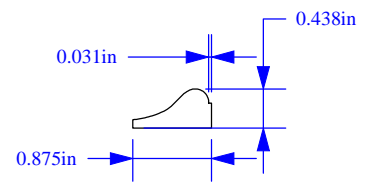

BC0752

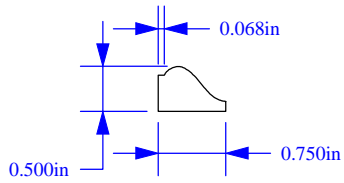

BC1001

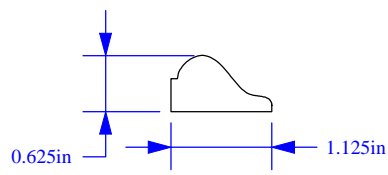

BC1013

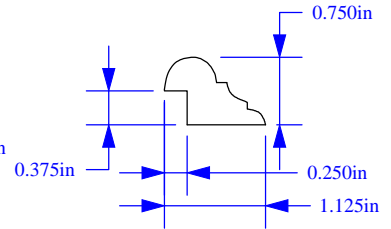

BC0753

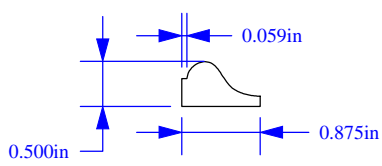

BC1002

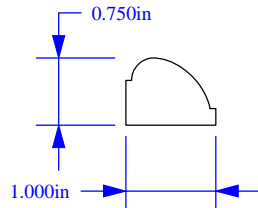

BC1014

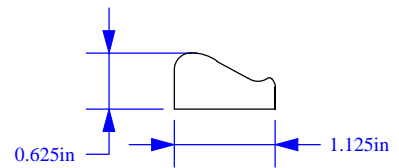

BC0754

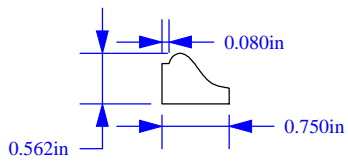

BC1008

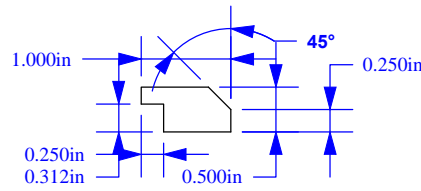

BC1015

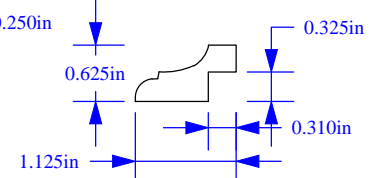

BC0755

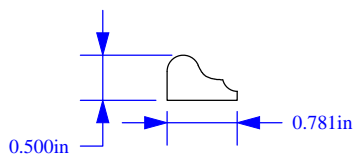

BC1009

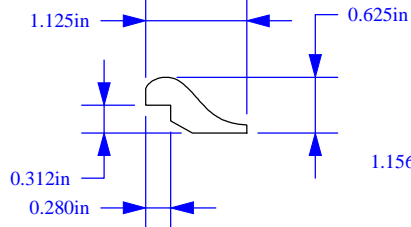

BC1016

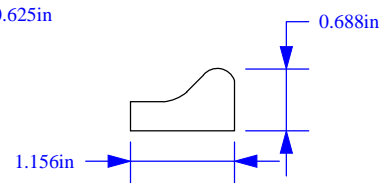

BC0756

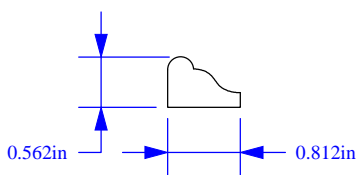

BC1010

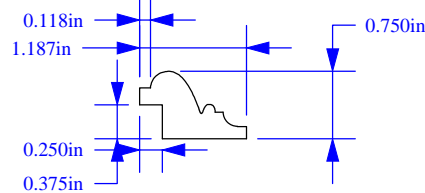

BC0757

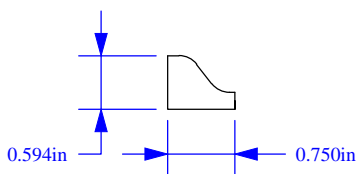

BC1011

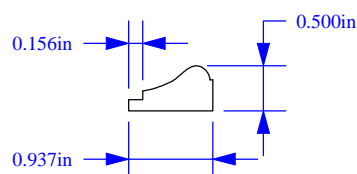

BC1251

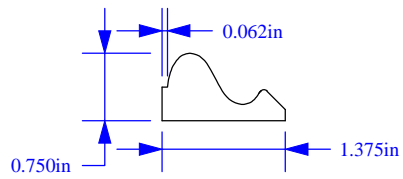

BC1263

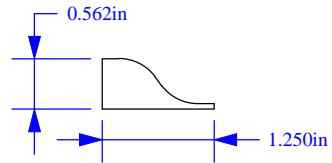

BC1252

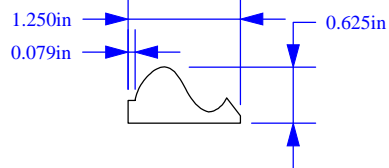

BC1264

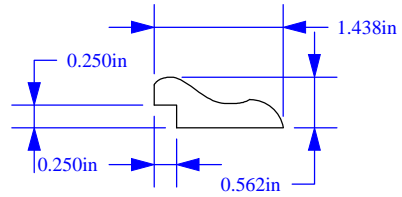

BC1253

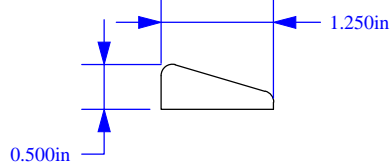

BC1265

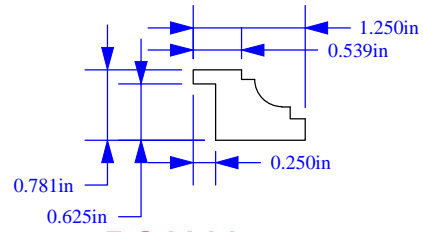

BC1256

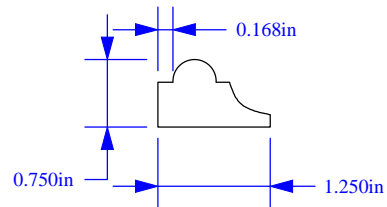

BC1266

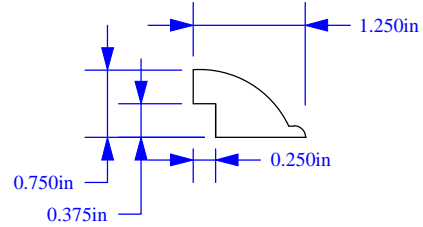

BC1259

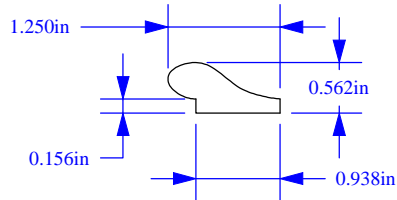

BC1261

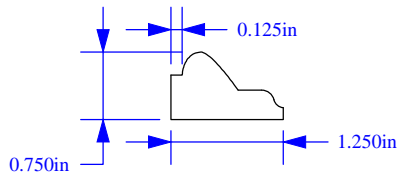

BC1262

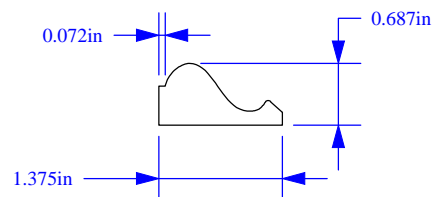

BC1501

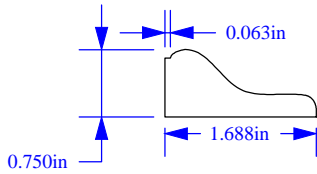

BC1509

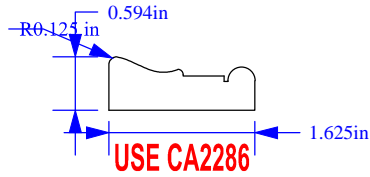

BC1516

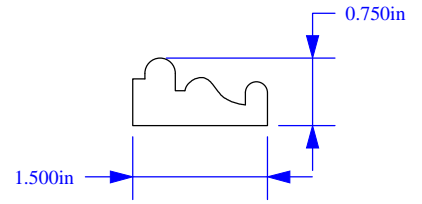

BC1502

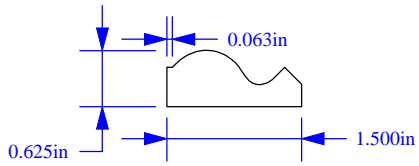

BC1510

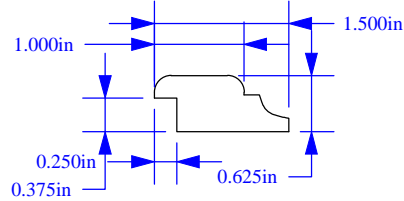

BC1503

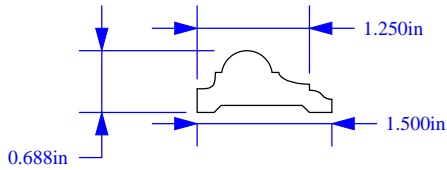

BC1511

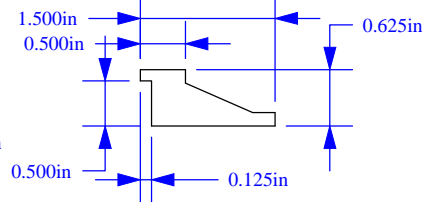

BC1518

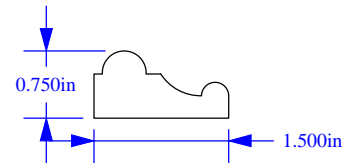

BC1504

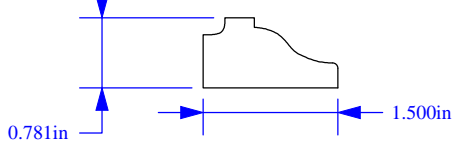

BC1512

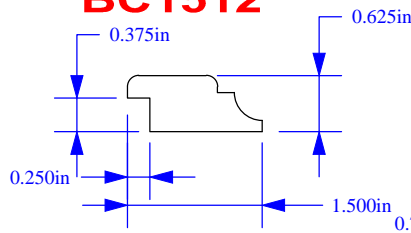

BC1519

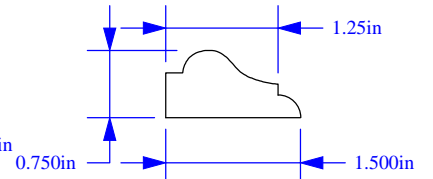

BC1505

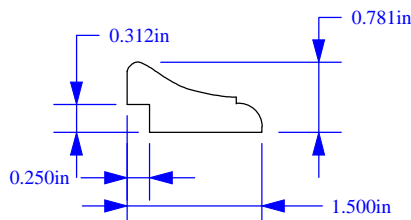

BC1513

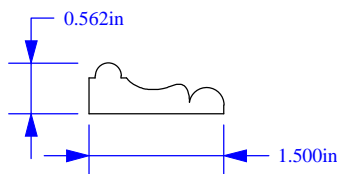

BC1547

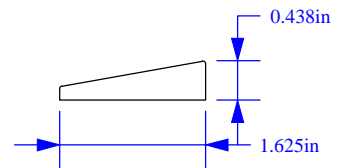

BC1507

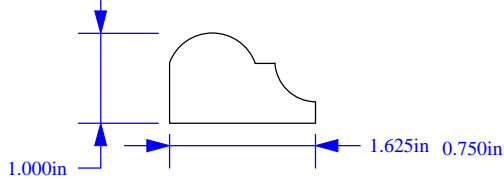

BC1514

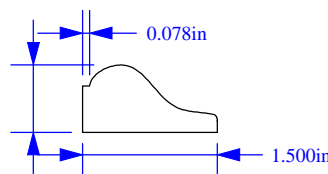

BC1508

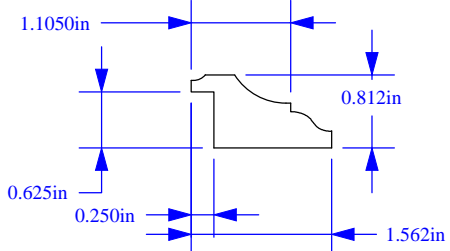

BC1515

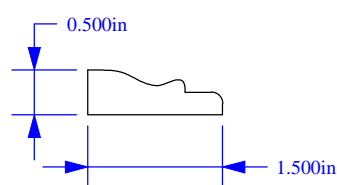

BC1751

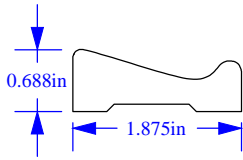

BC1759

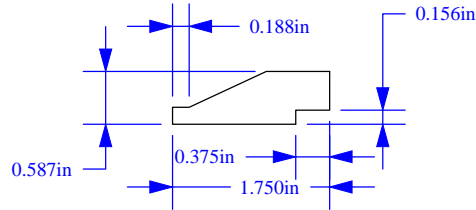

BC2004

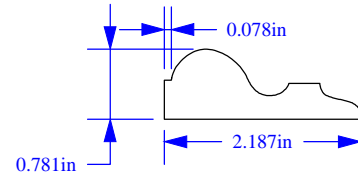

BC1752

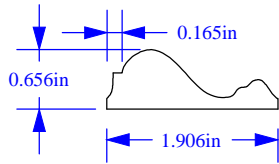

BC1760

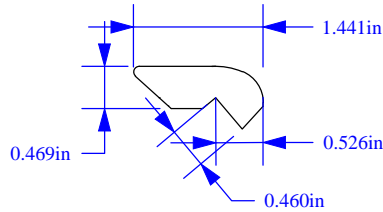

BC2005

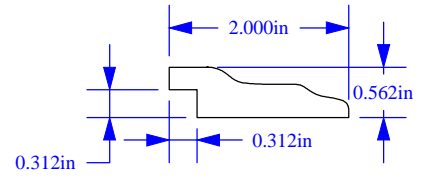

BC1754

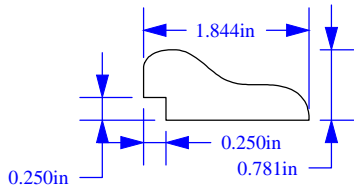

BC1761

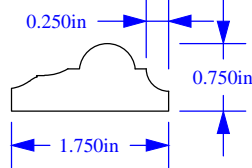

BC2006

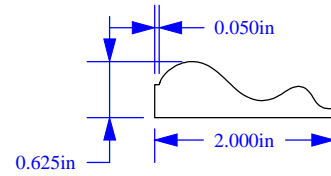

BC1755

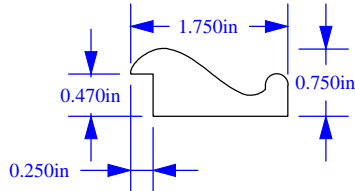

BC1800

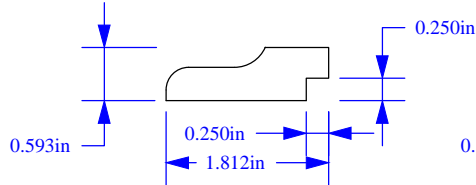

BC2007

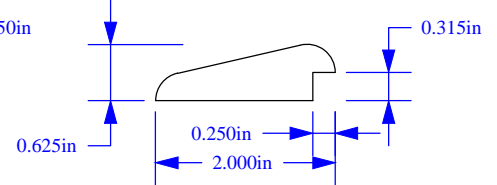

BC1756

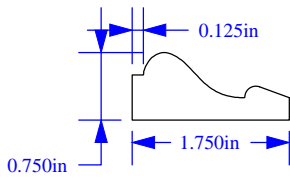

BC2001

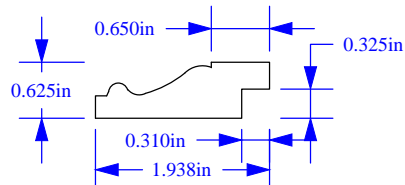

BC2008

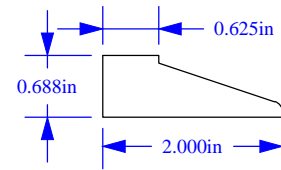

BC1757

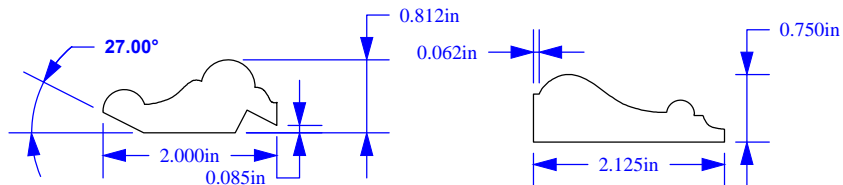

BC2002

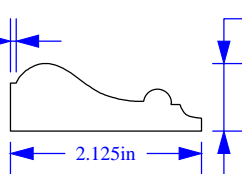

BC1758

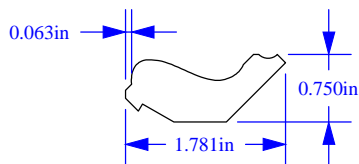

BC2003

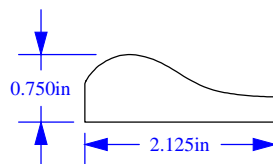

BC2100

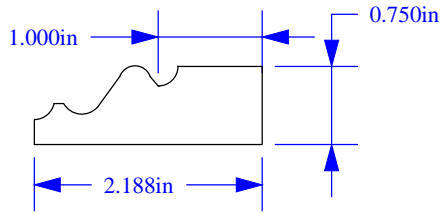

BC2255

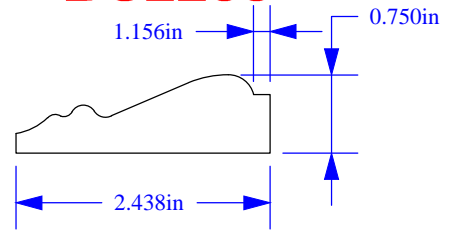

BC2101

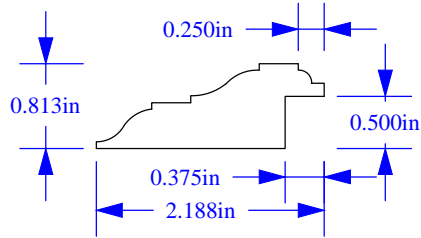

BC2256

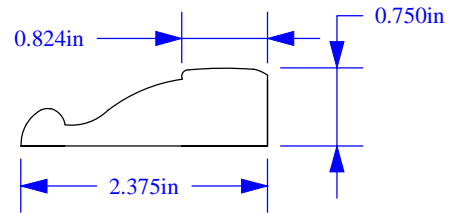

BC2251

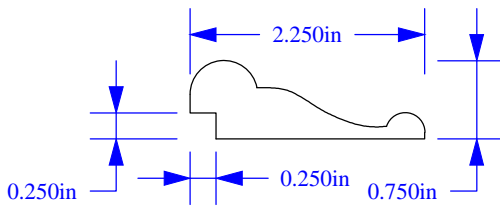

BC2257

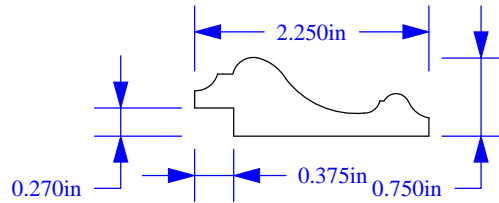

BC2252

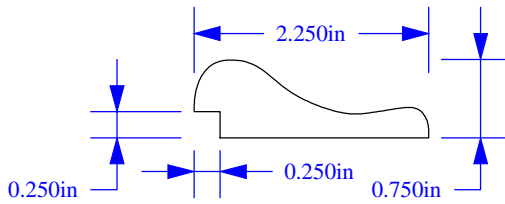

BC2258

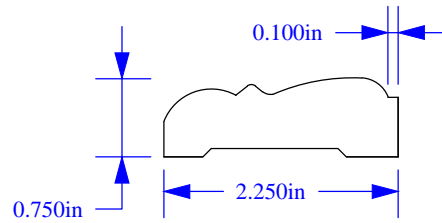

BC2253

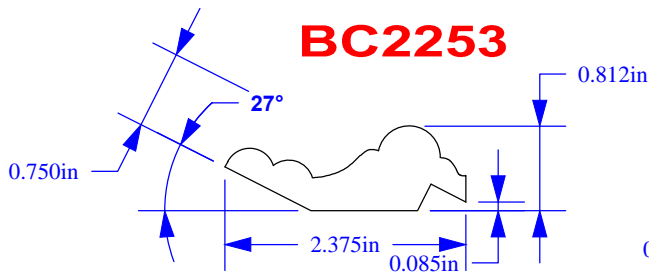

BC2259

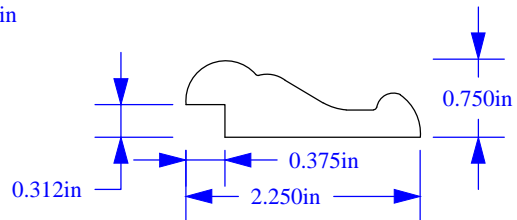

BC2254

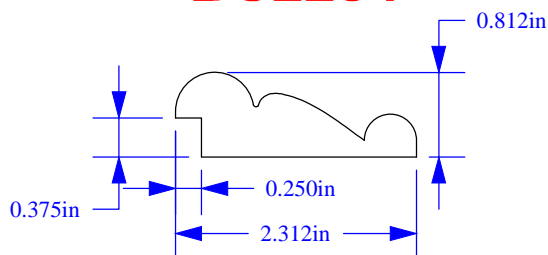

BC2260

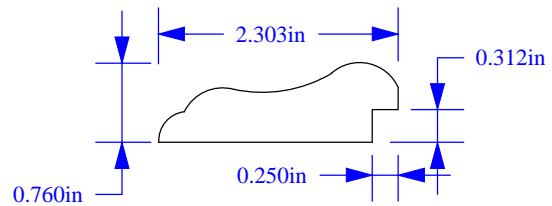

BC2500

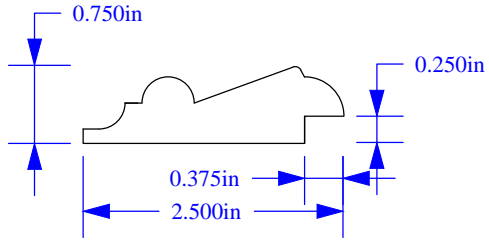

BC3180

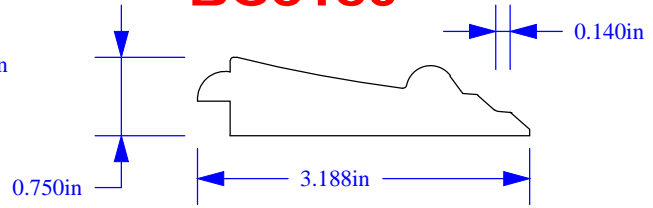

BC2501

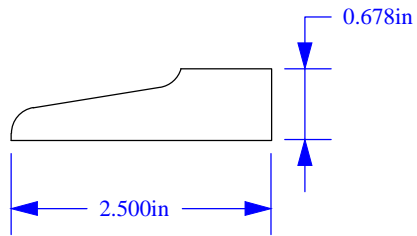

BC3251

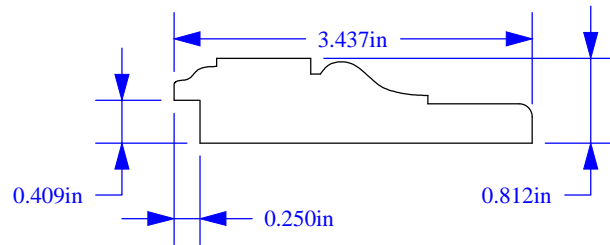

BC2751

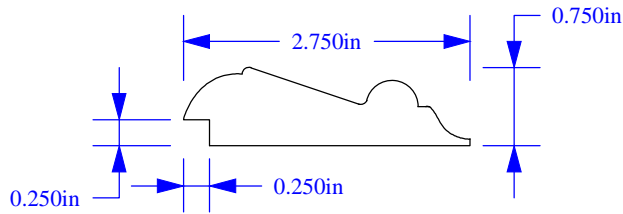

BC4000

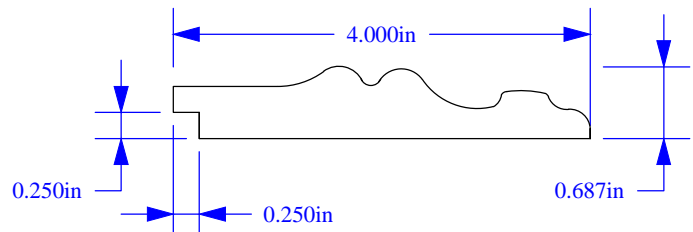

BC2752

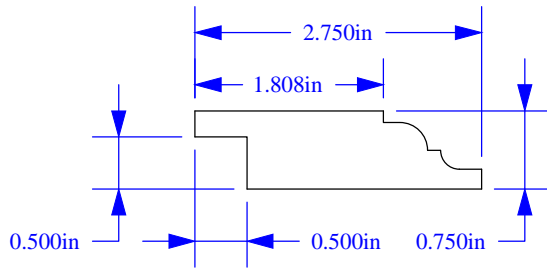

BC5001

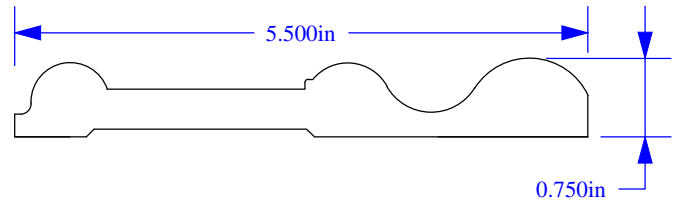

BC2753

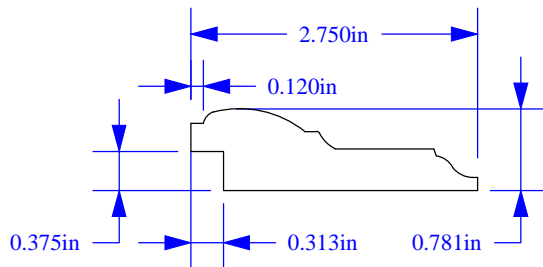

BC3001

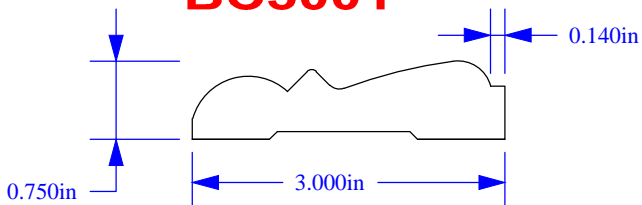

CA1501

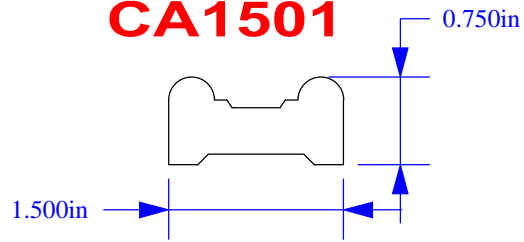

CA1751

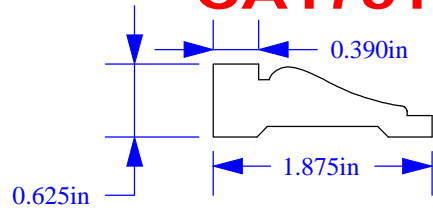

CA1753

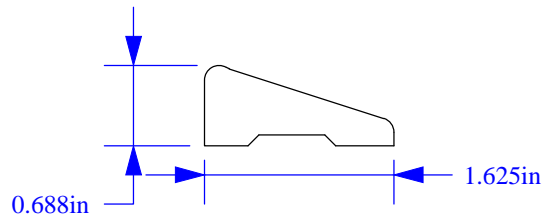

CA1754

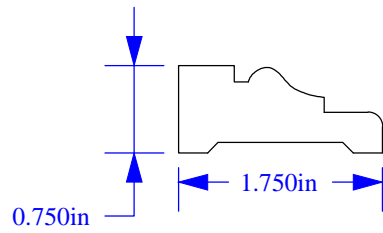

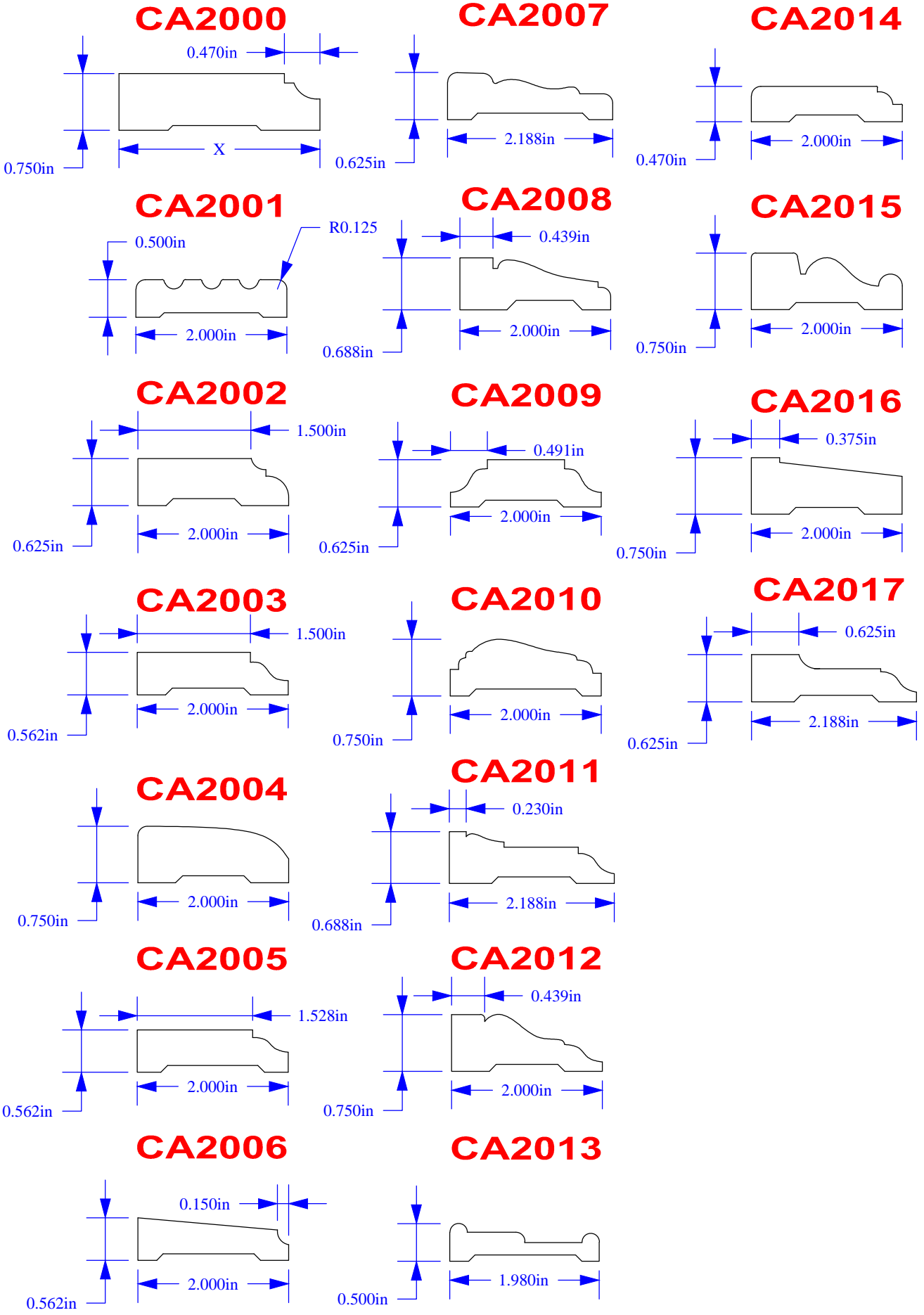

CA2251

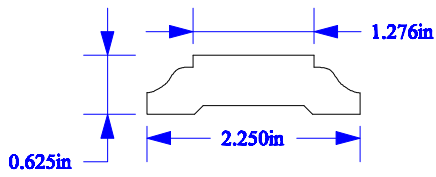

CA2259

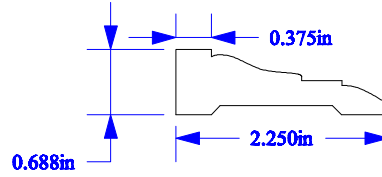

CA2252

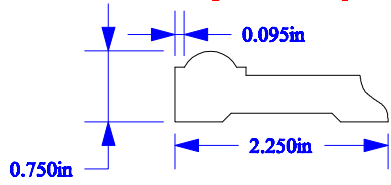

CA2260

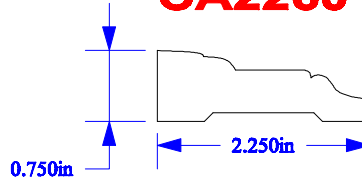

CA2253

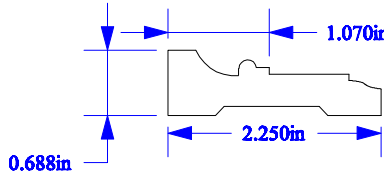

CA2261

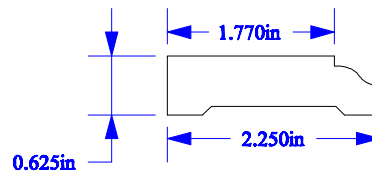

CA2254

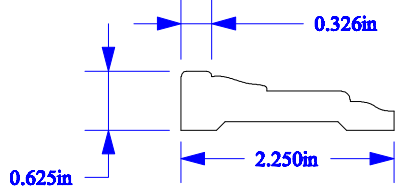

CA2262

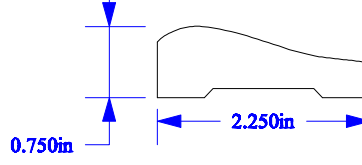

CA2255

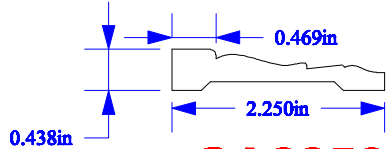

CA2263

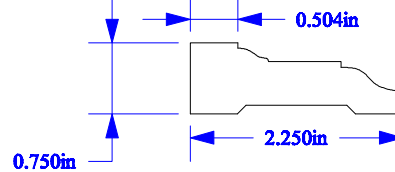

CA2256

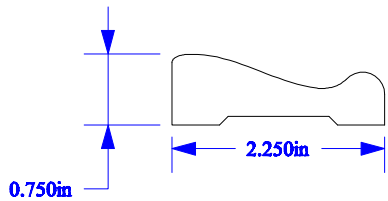

CA2264

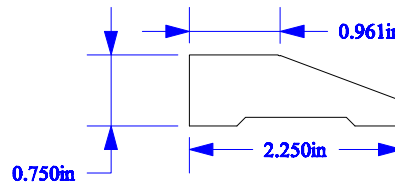

CA2257

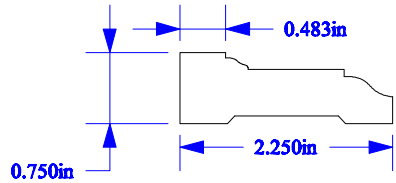

CA2265

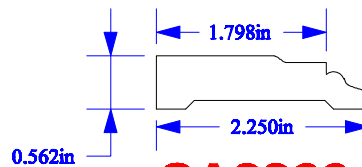

CA2258

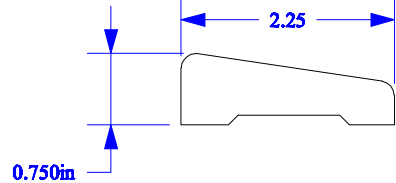

CA2266

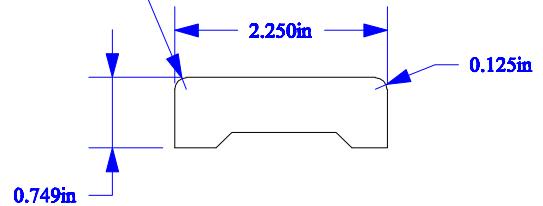

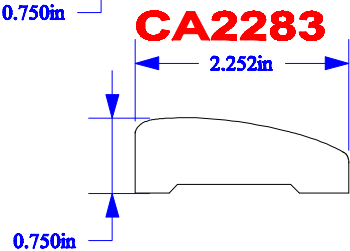
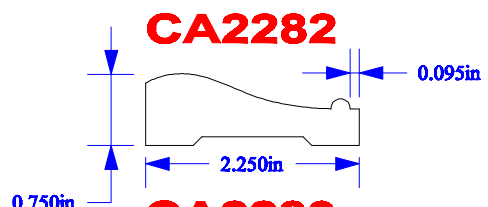
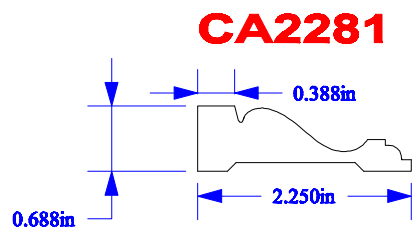
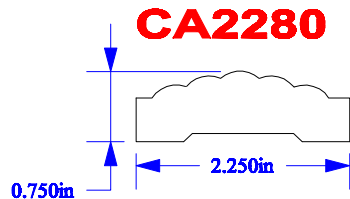
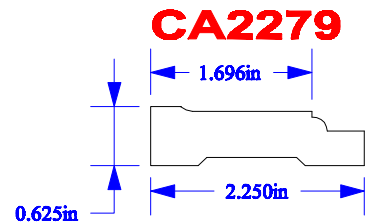
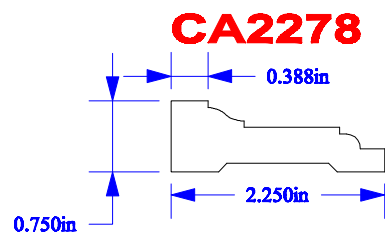
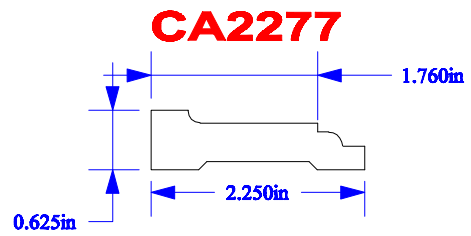
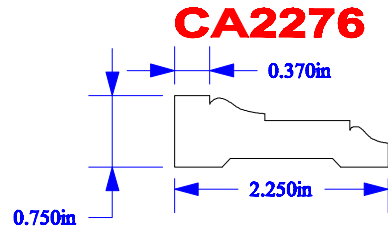
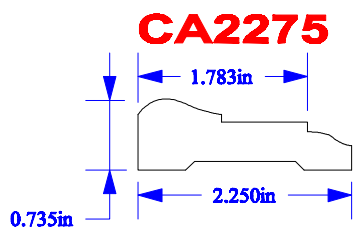
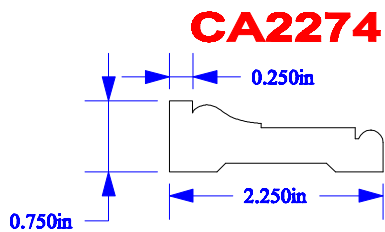
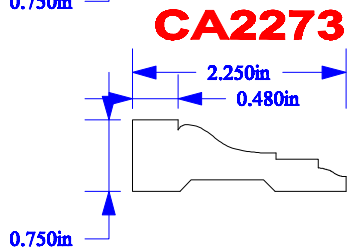
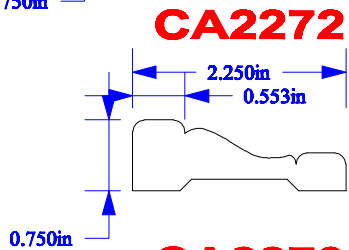
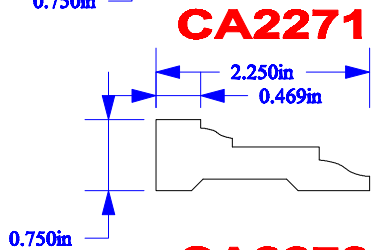
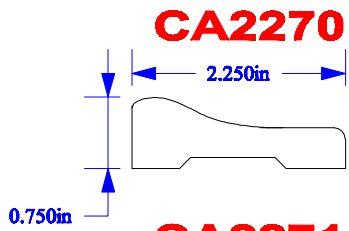
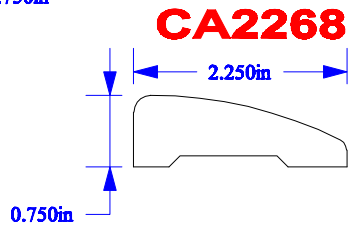
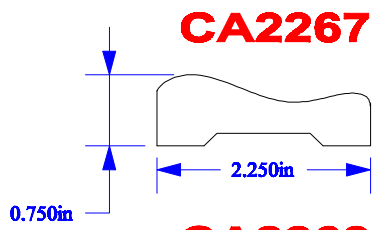

CA2284

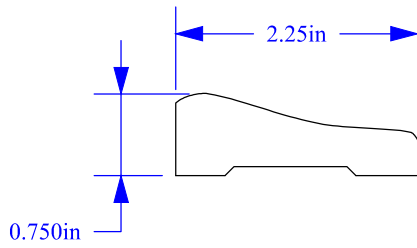

CA2291

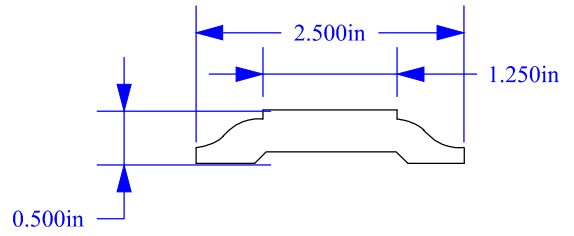

CA2285

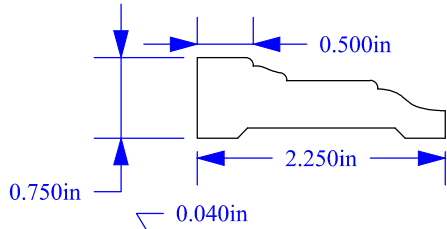

CA2293

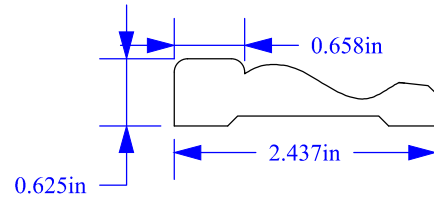

CA2286

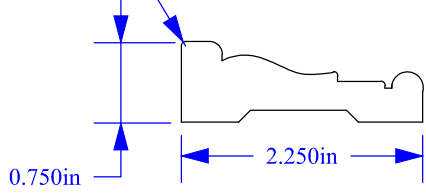

CA2294

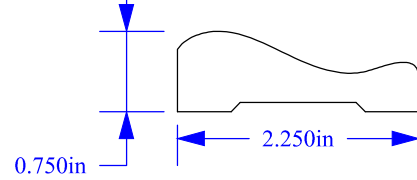

CA2287

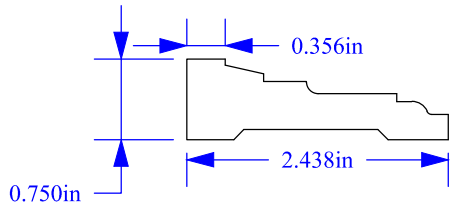

CA2295

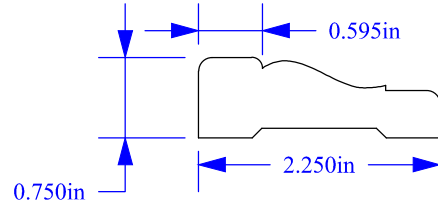

CA2288

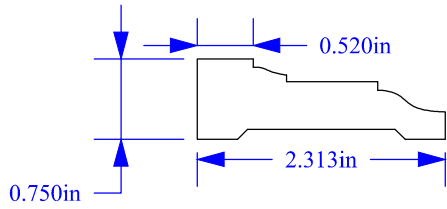

CA2296

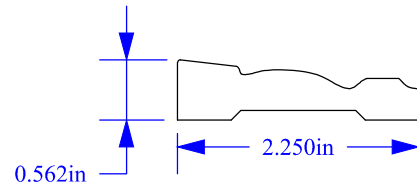

CA2289

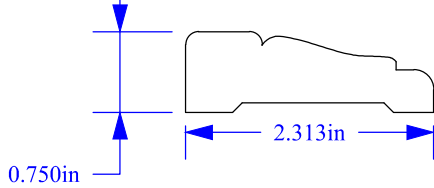

CA2297

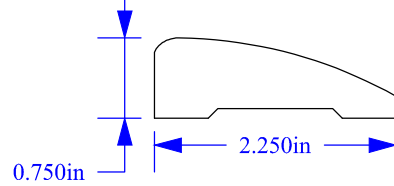

CA2290

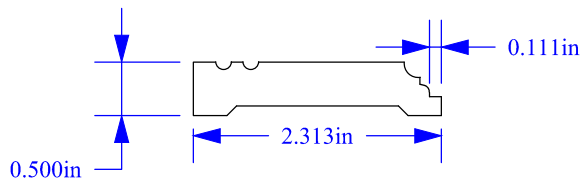

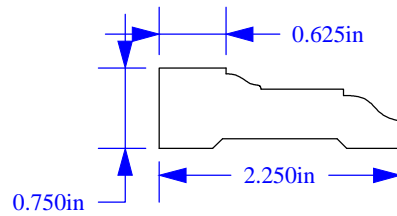
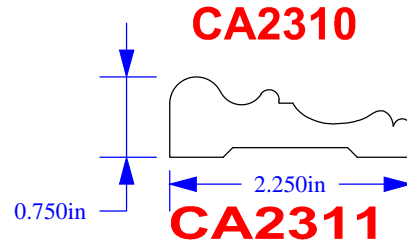
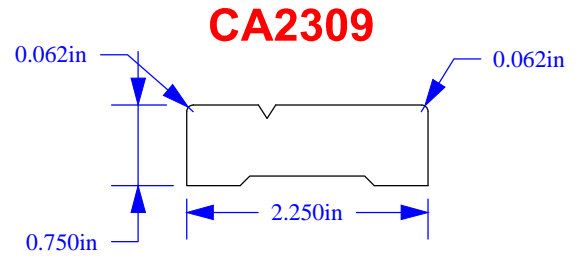
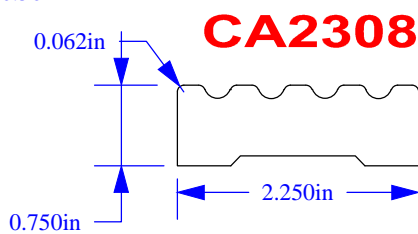
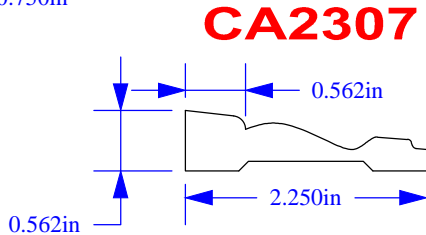
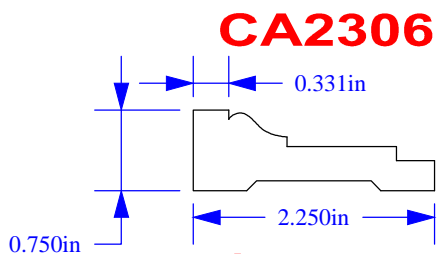
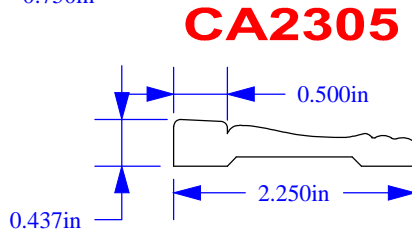
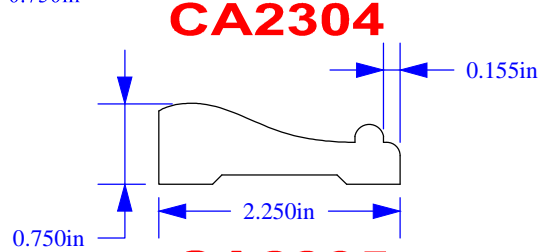
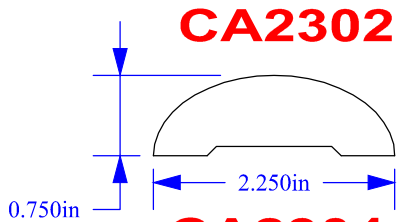
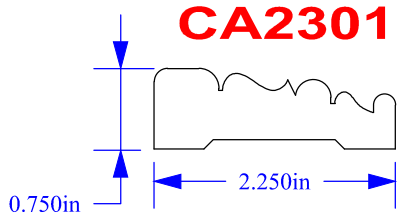
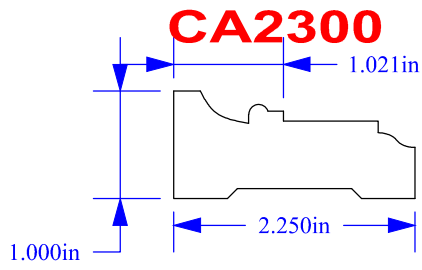

CA2501

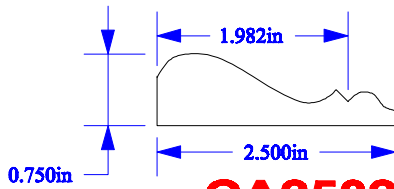

CA2502

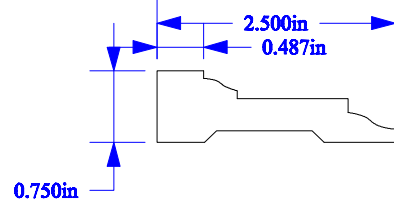

CA2503

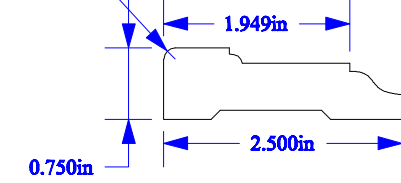

CA2504

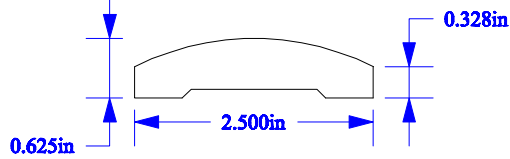

CA2505

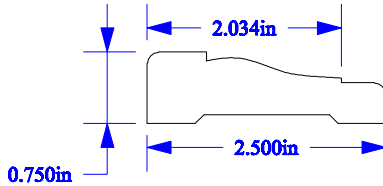

CA2506

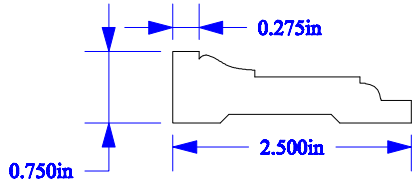

CA2507

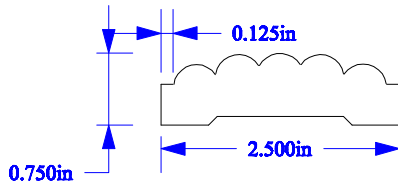

CA2508

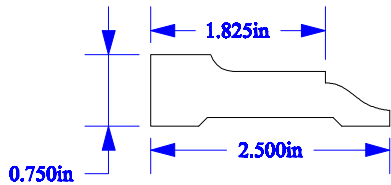

CA2509

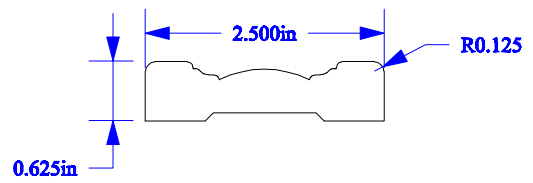

CA2510

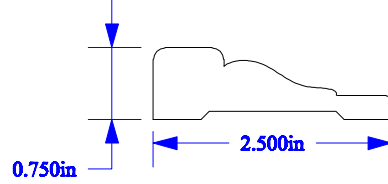

CA2511

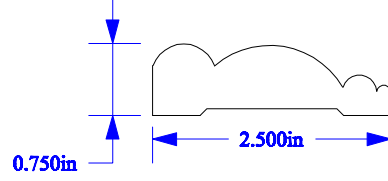

CA2512

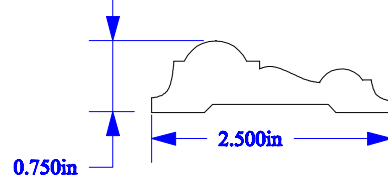

CA2513

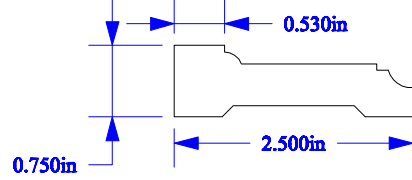

CA2514

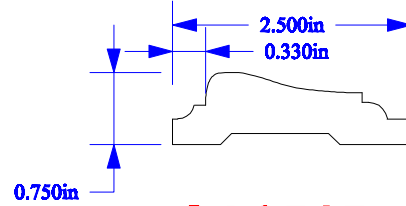

CA2515

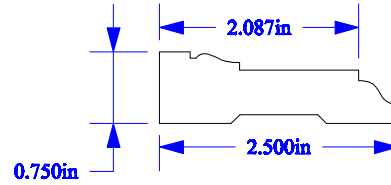

CA2516

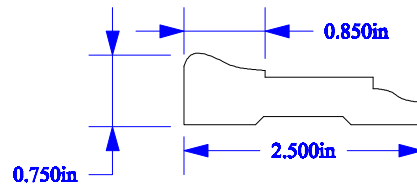

CA2517

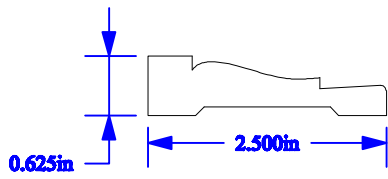

CA2525

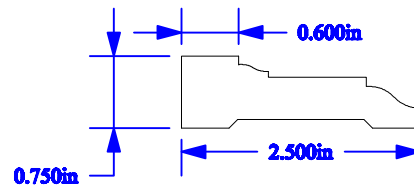

CA2518

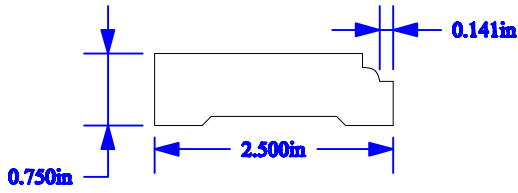

CA2526

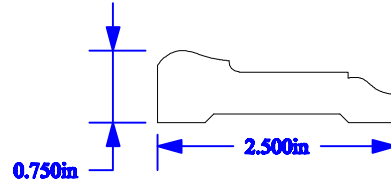

CA2519

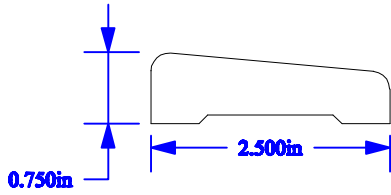

CA2527

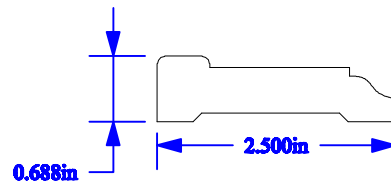

CA2520

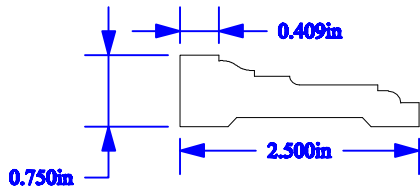

CA2528

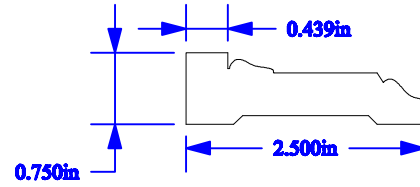

CA2521

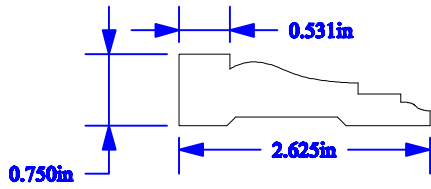

CA2529

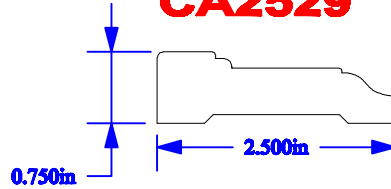

CA2522

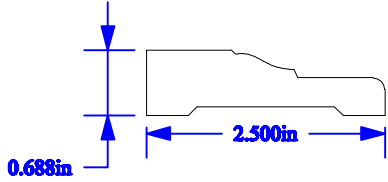

CA2530

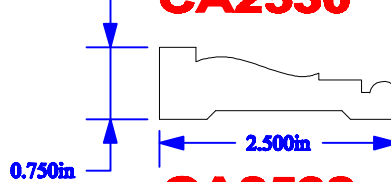

CA2523

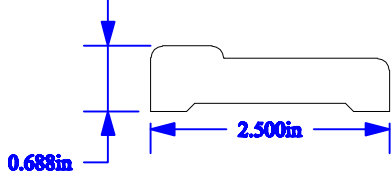

CA2532

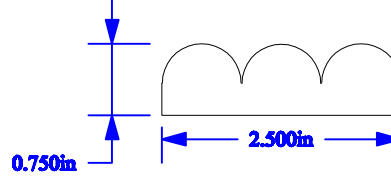

CA2524

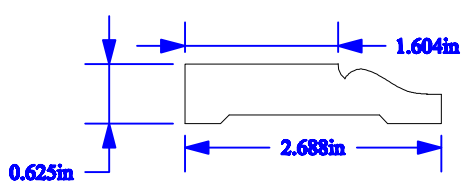

CA2534

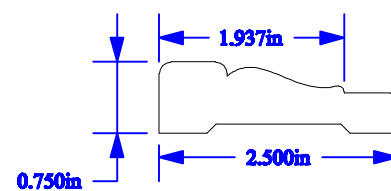

CA2535

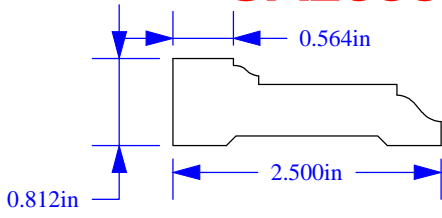

CA2541

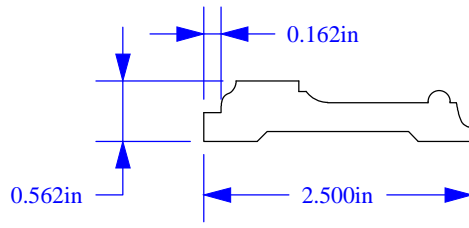

CA2536

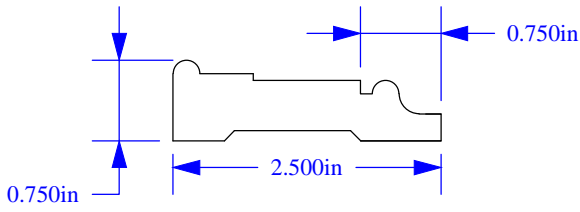

CA2542

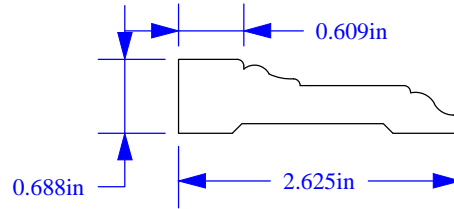

CA2537

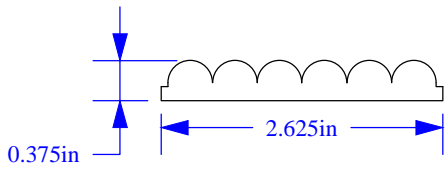

CA2538

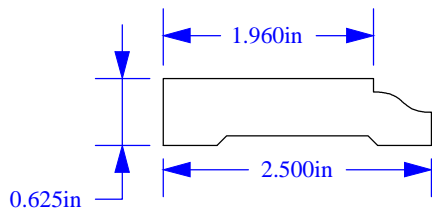

CA2539

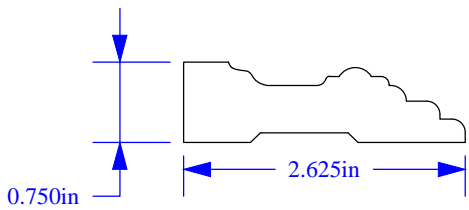

CA2540

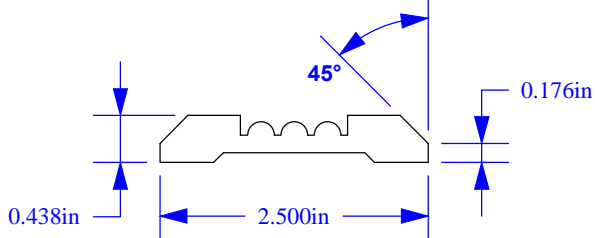

CA2751

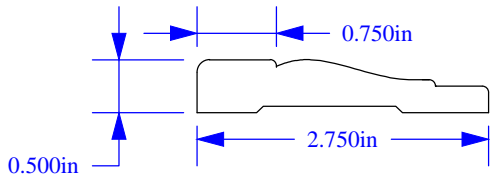

CA2758

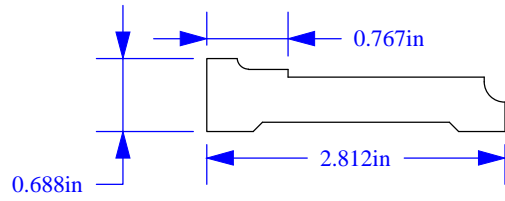

CA2752

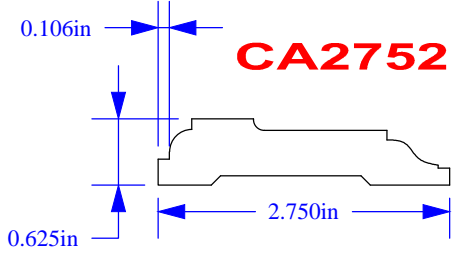

CA2759

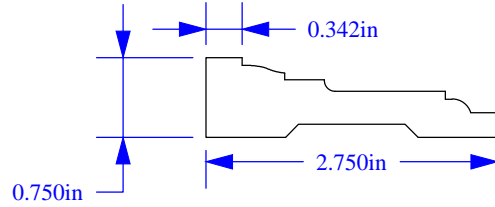

CA2753

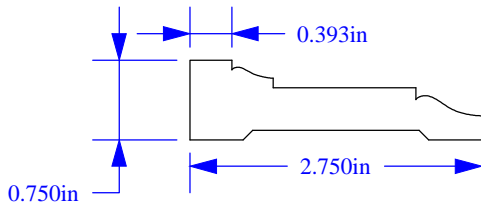

CA2760

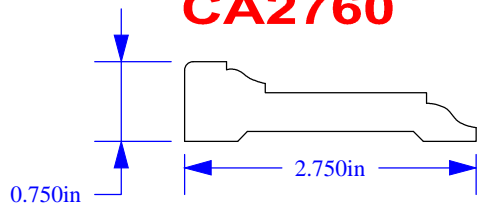

CA2754

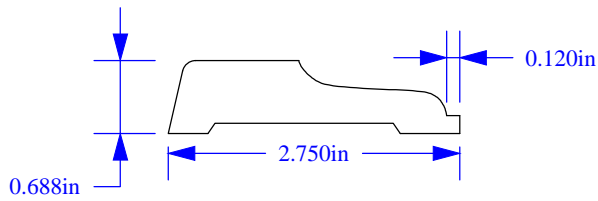

CA2761

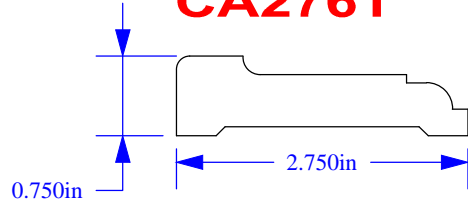

CA2755

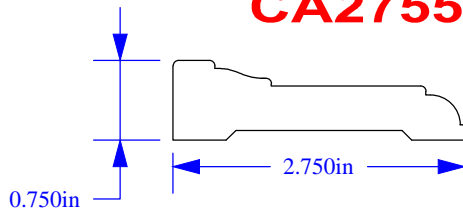

CA2762

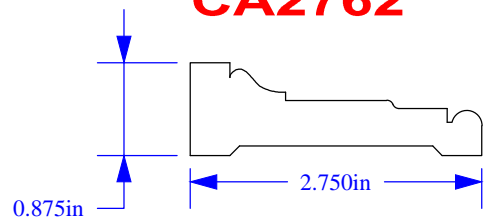

CA2756

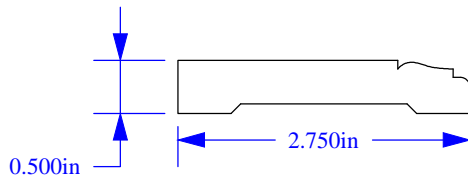

CA2763

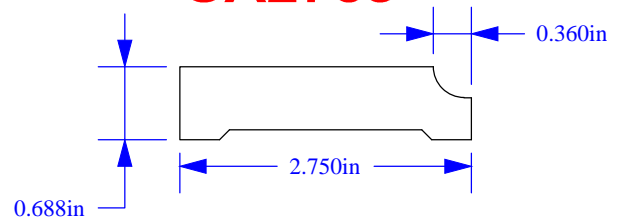

CA2757

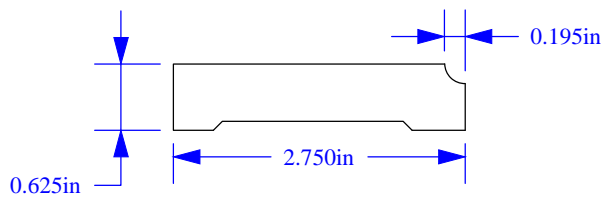

CA2764

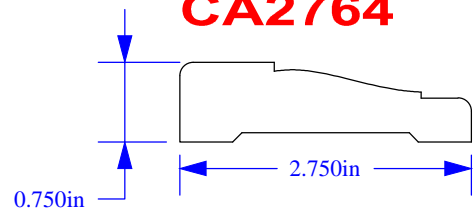

CA2765

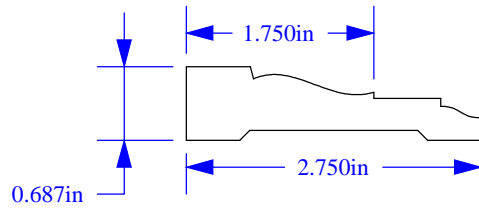

CA2766

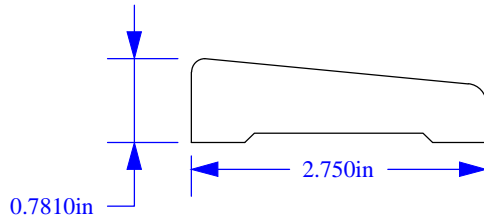

CA2769

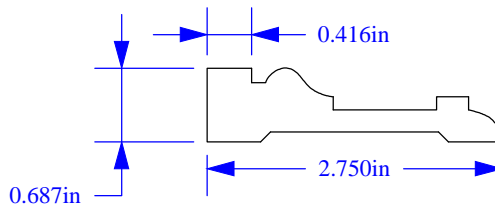

CA2770

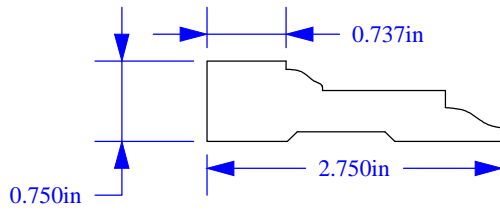

CA2771

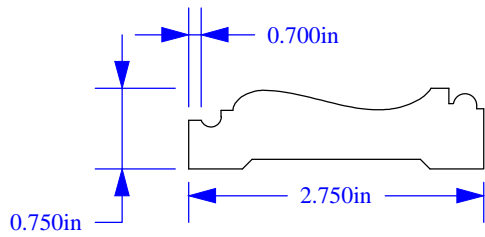

CA2772

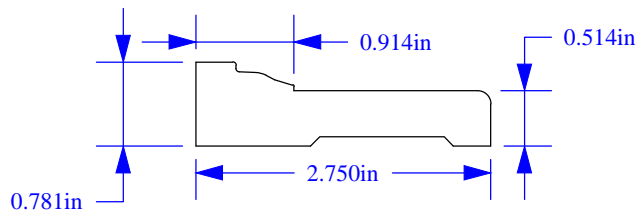

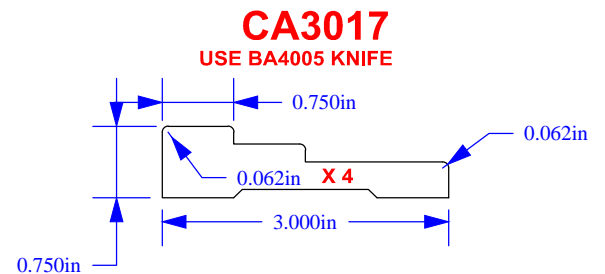
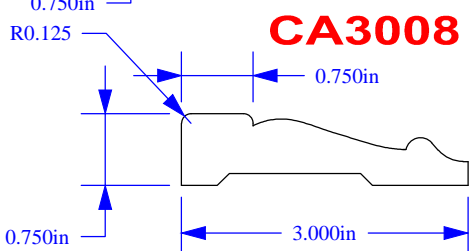
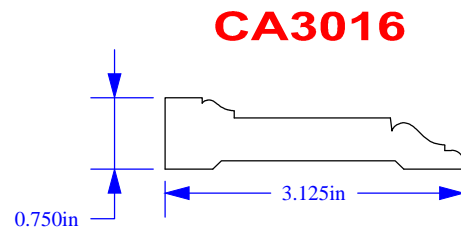
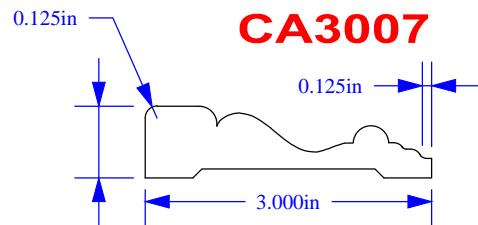
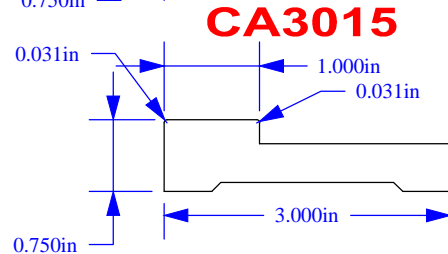
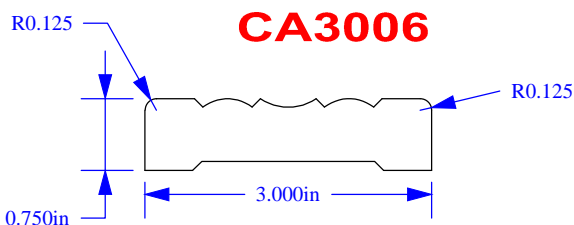
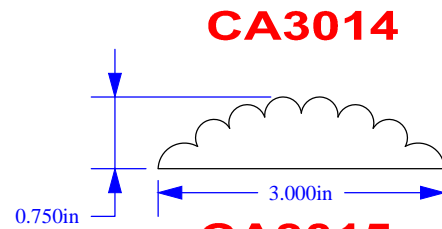
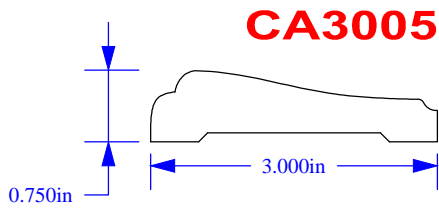
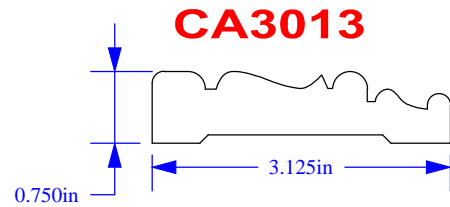
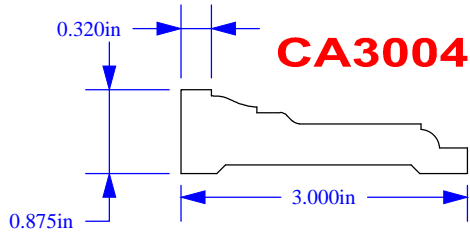
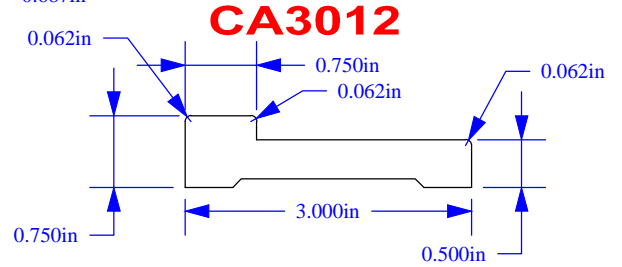
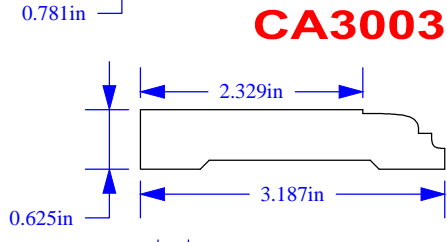
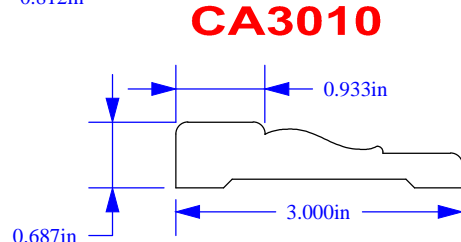
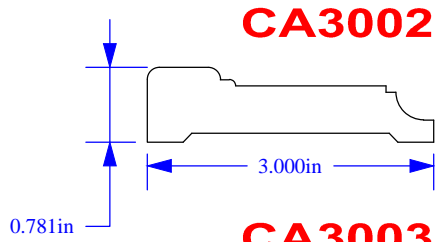
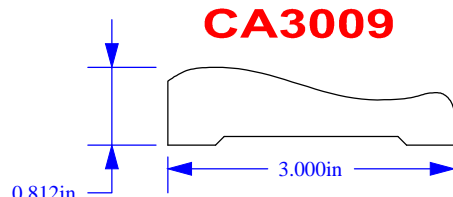
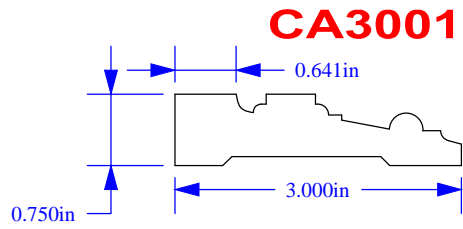

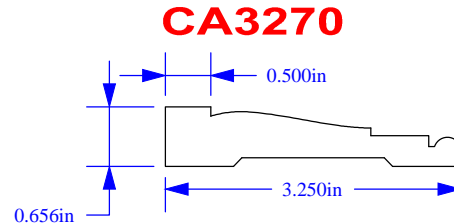
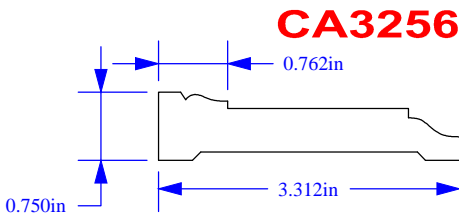
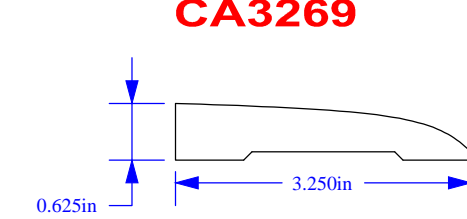
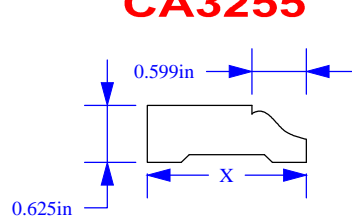
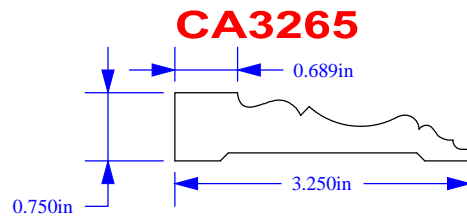
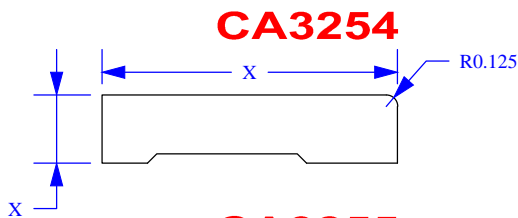
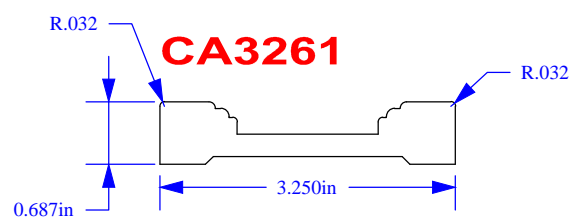
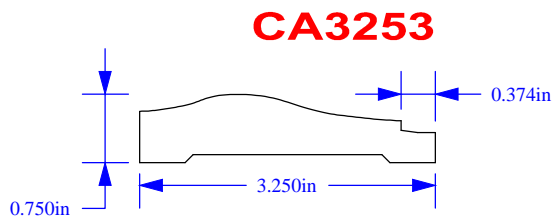
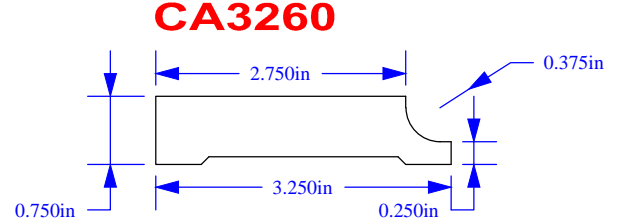
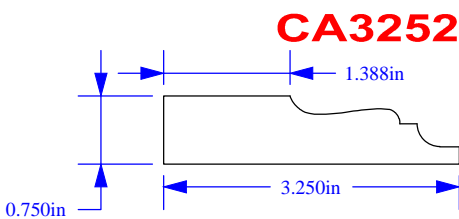
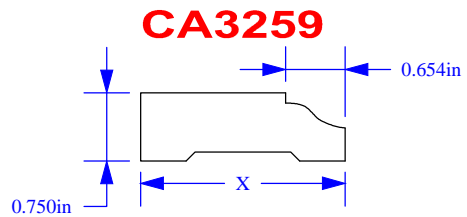
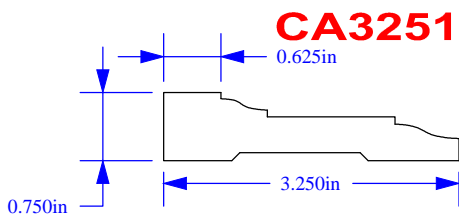
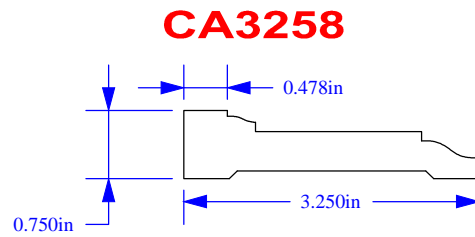
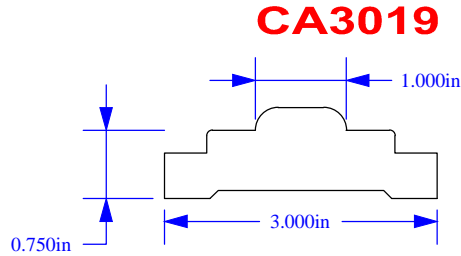
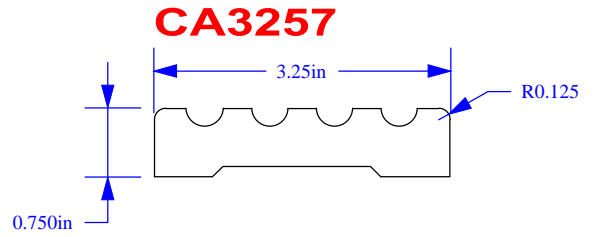
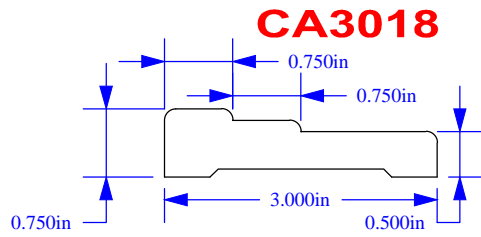

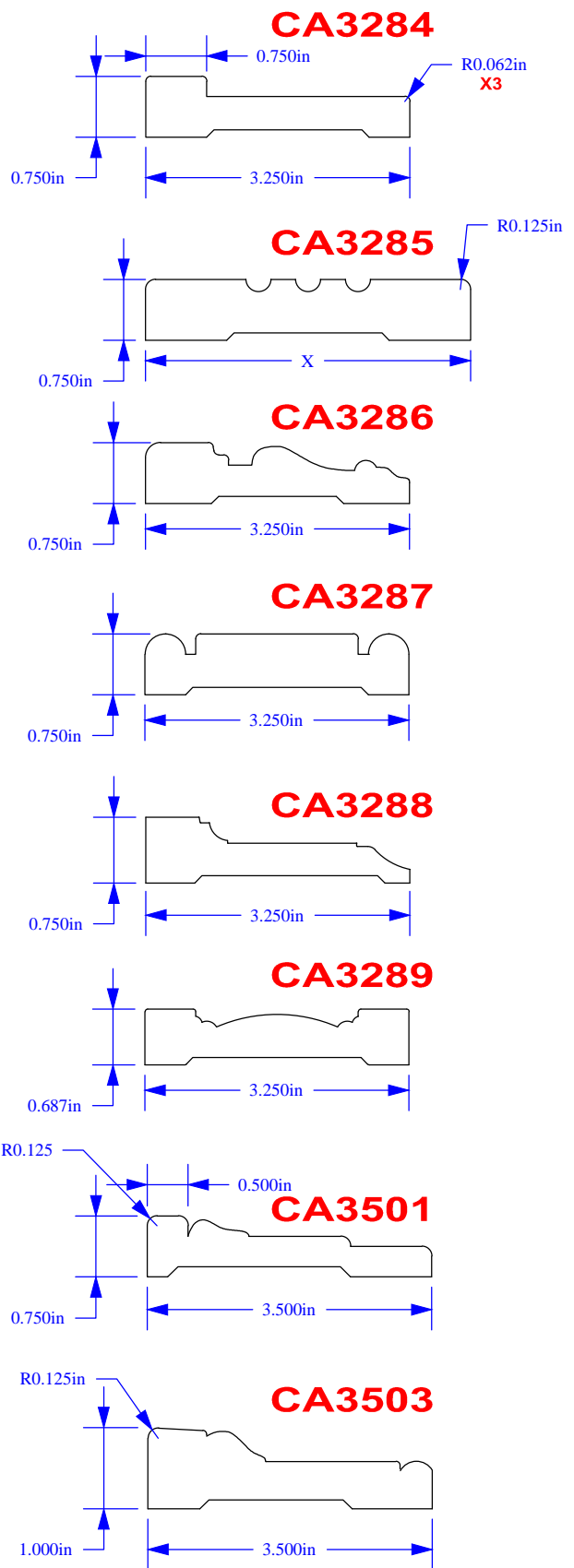
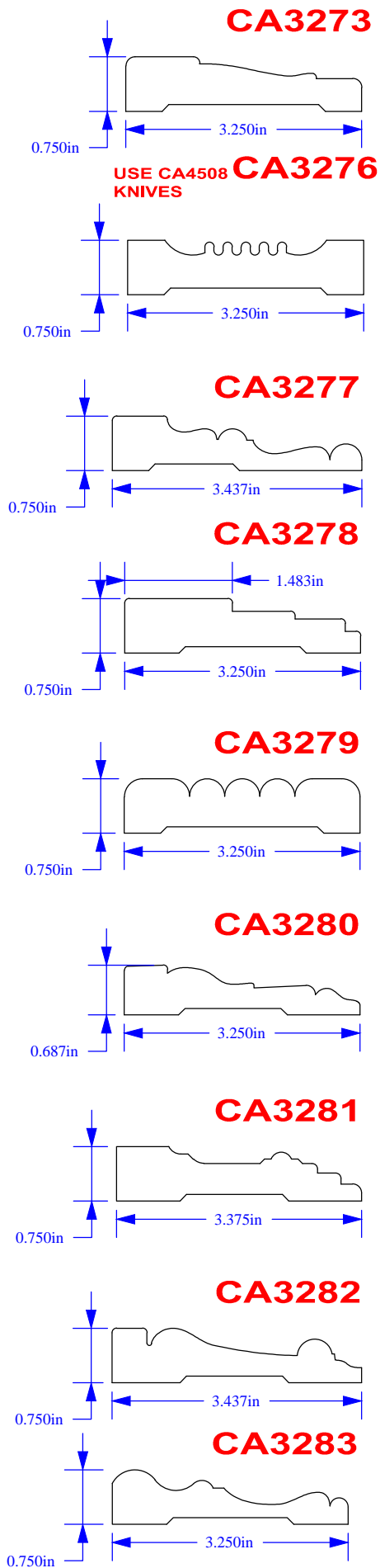

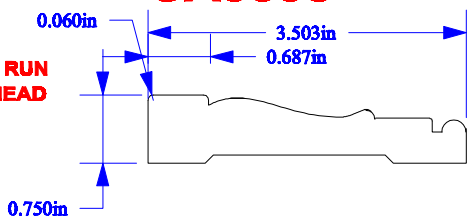
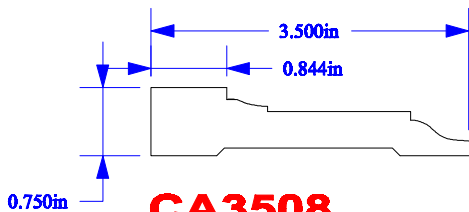
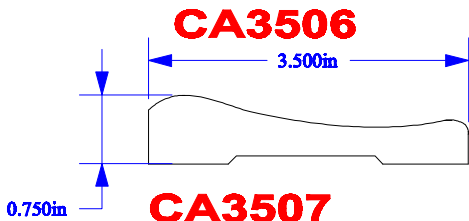
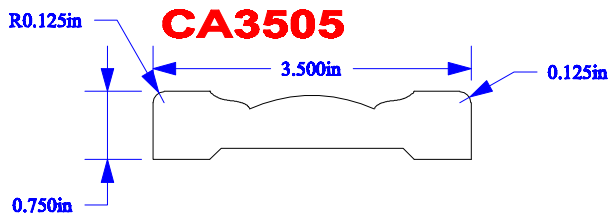
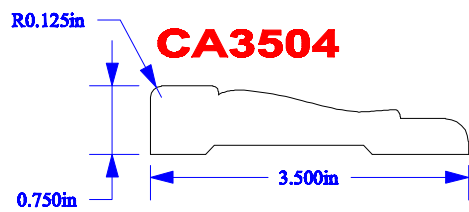

**NEED TO RUN
 IN SIDE HEAD**

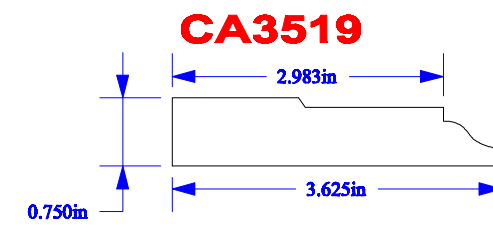
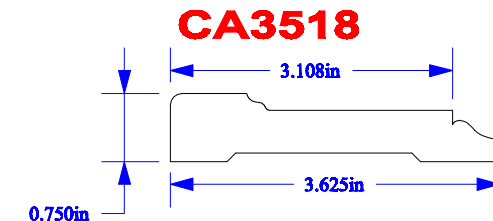
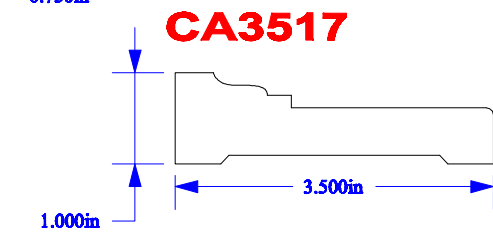
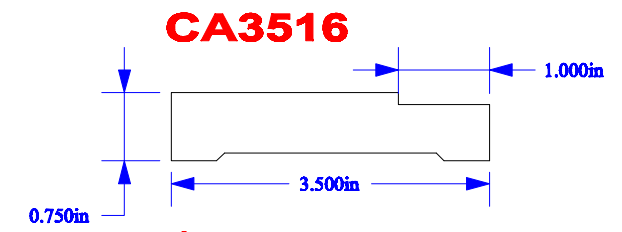
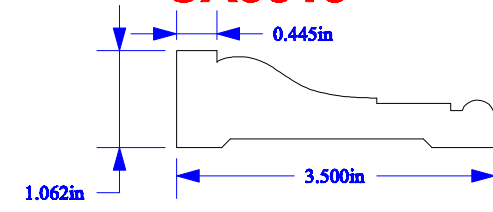
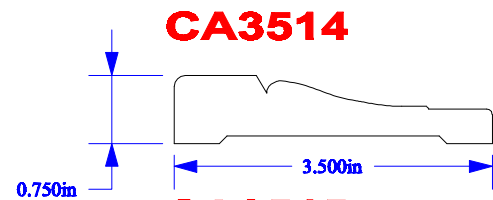
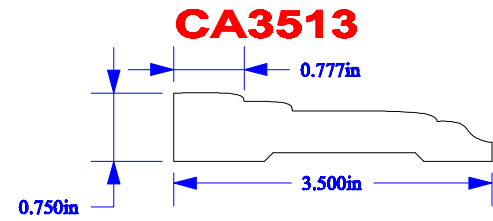
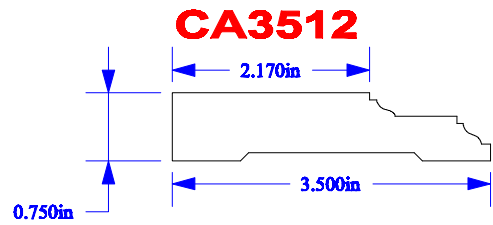
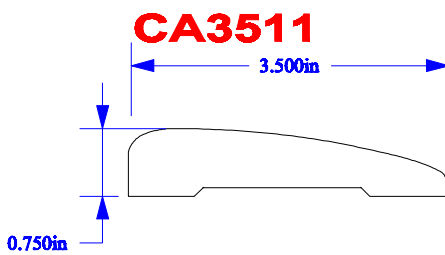
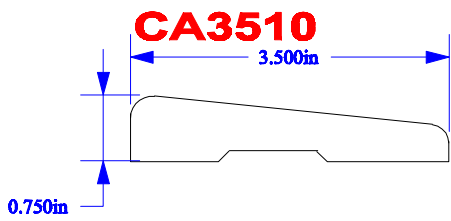
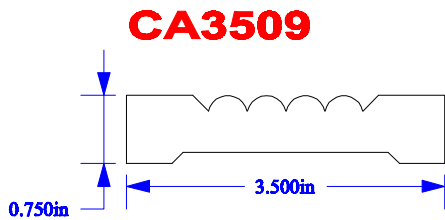

CA3525

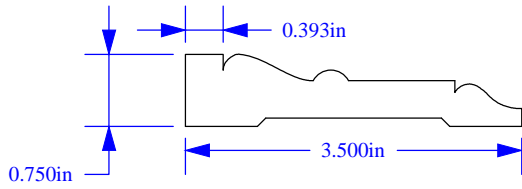

CA3526

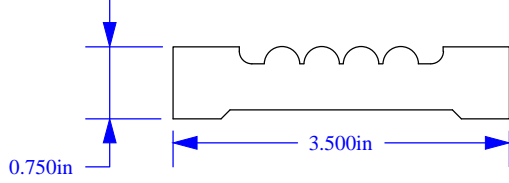

CA3527

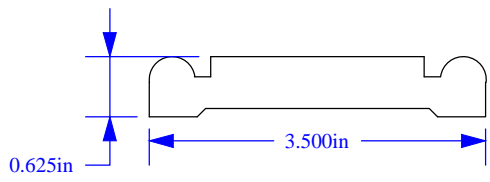

CA3529

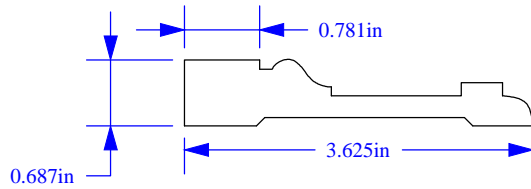

CA3530

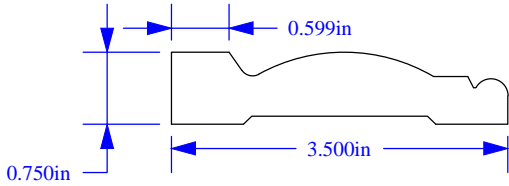

CA3531

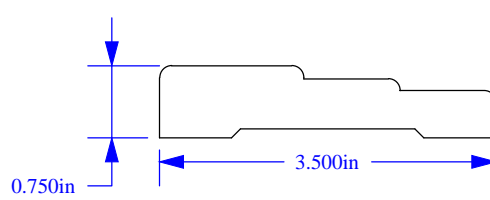

CA3532

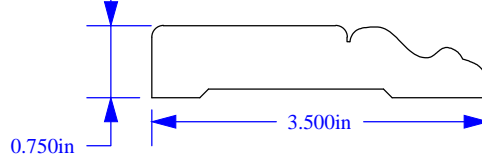

CA3533

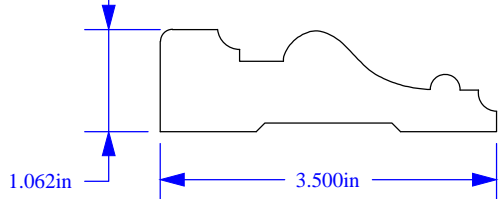

CA3534

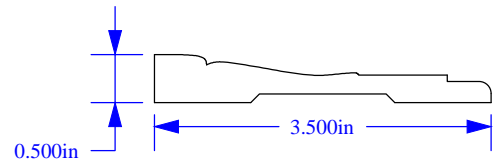

CA3535

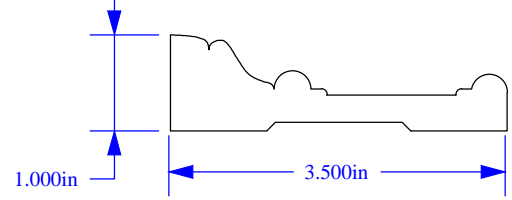

CA3536

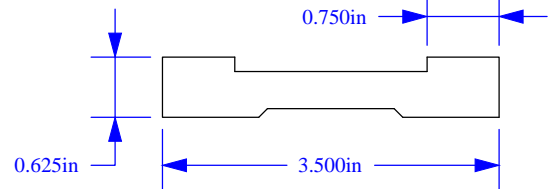

CA3537

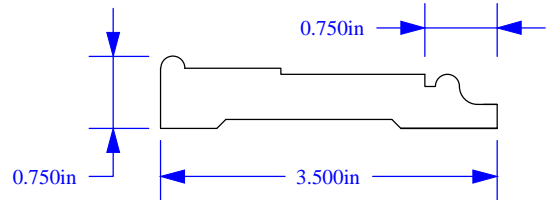

CA3538

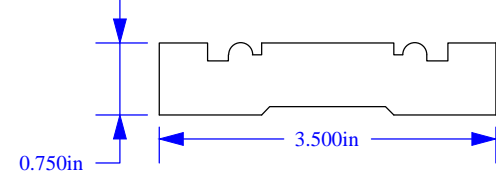

CA3751

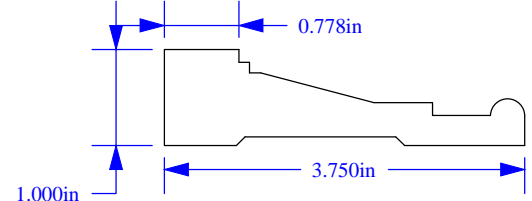

CA3752

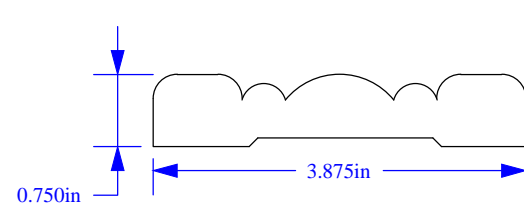

CA3753

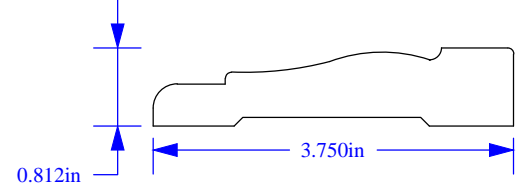

CA4001

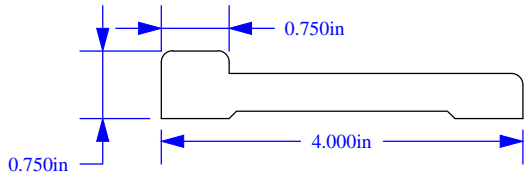

CA4002

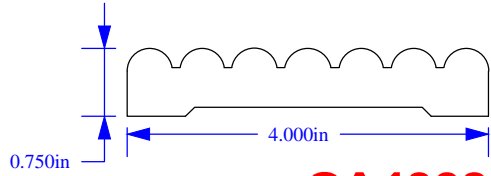

CA4003

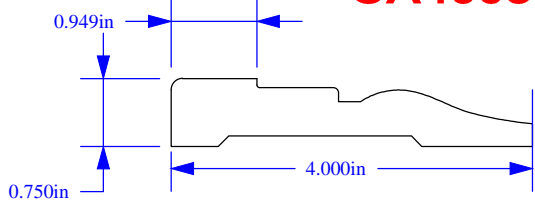

CA4004

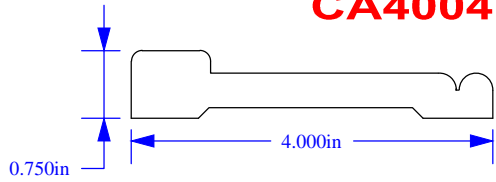

CA4005

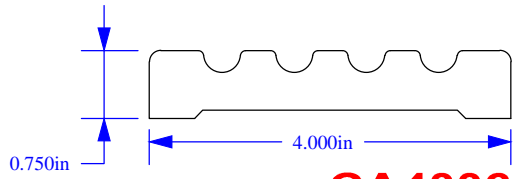

CA4006

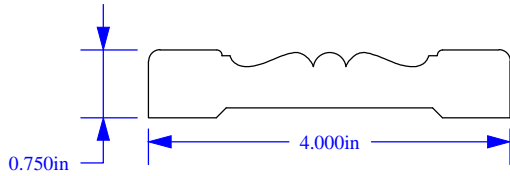

CA4007

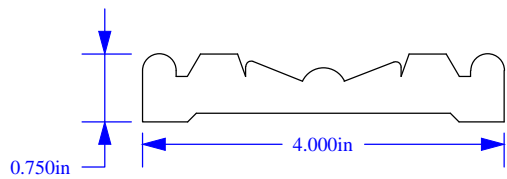

CA4009

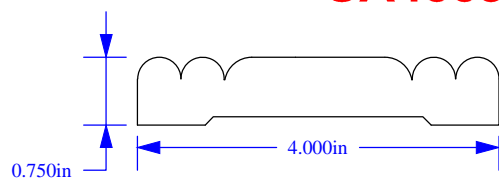

CA4010

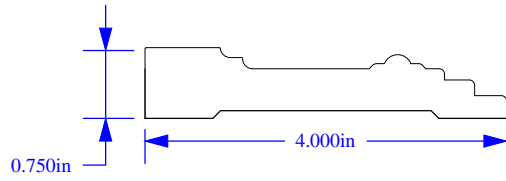

CA4011

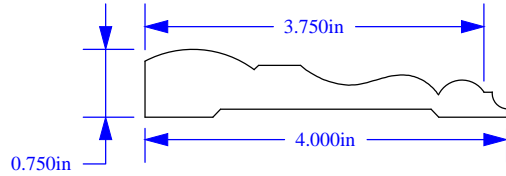

CA4012

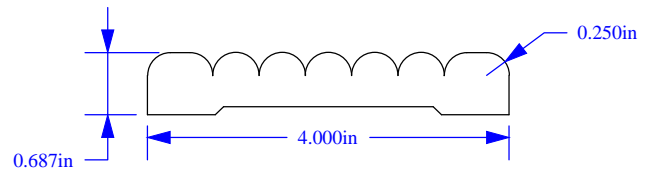

CA4014

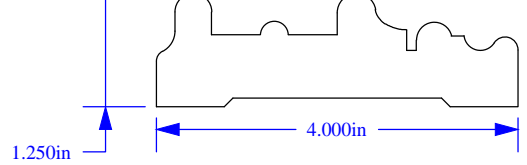

CA4015

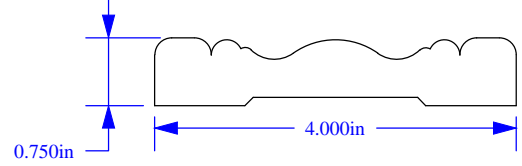

CA4016

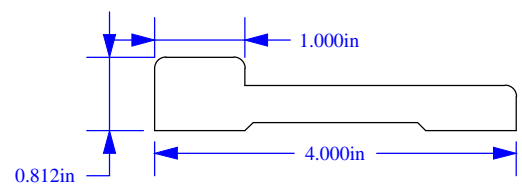

CA4100

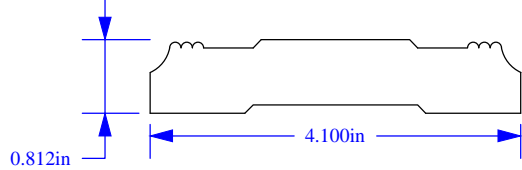

CA4101

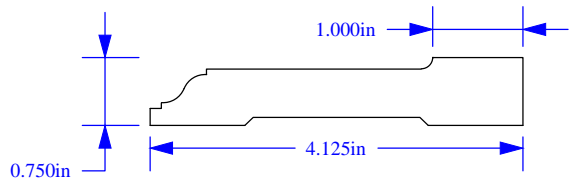

CA4251

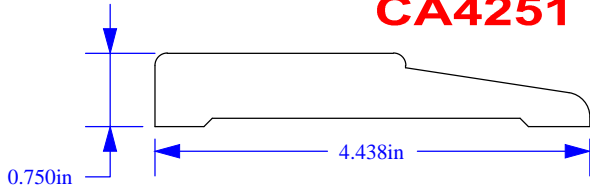

CA4300

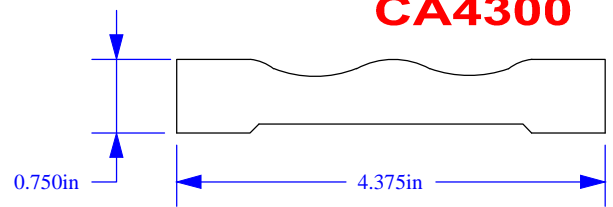

CA4252

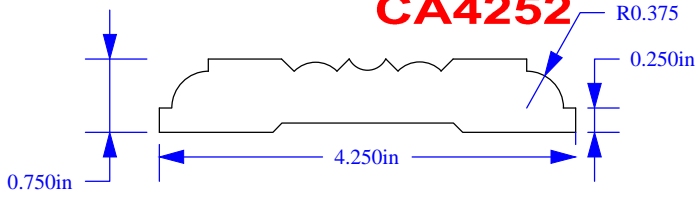

CA4253

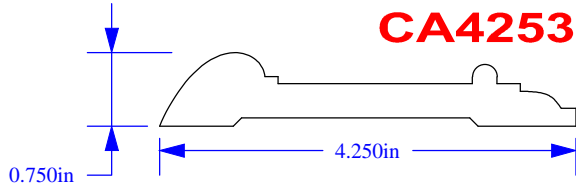

CA4254

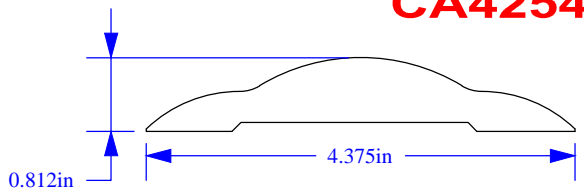

CA4255

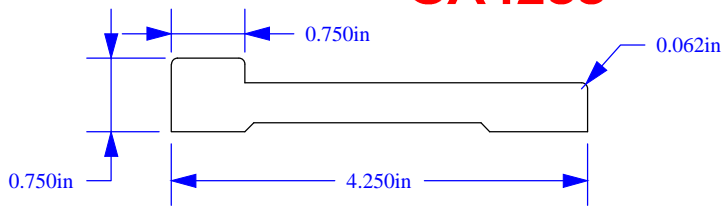

CA4256

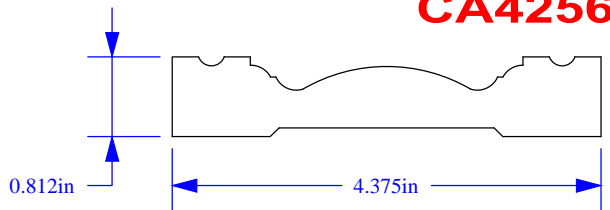

CA4257

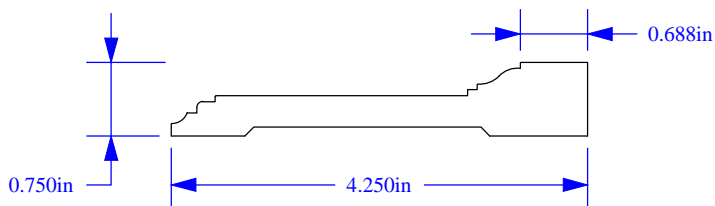

CA4258

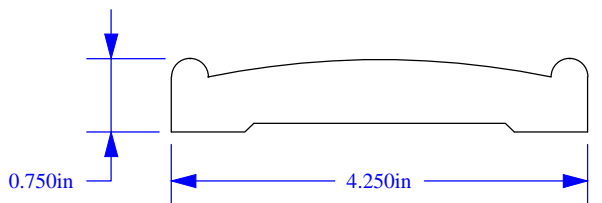

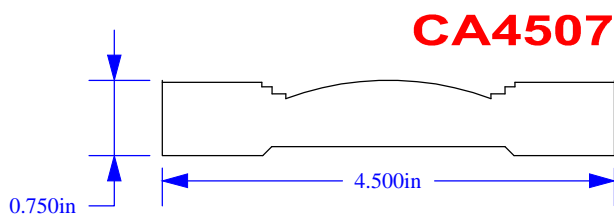
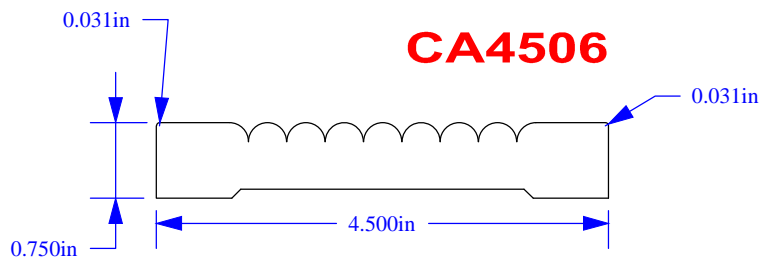
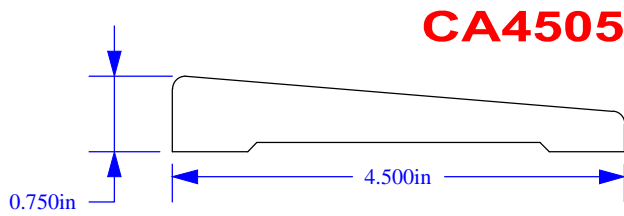
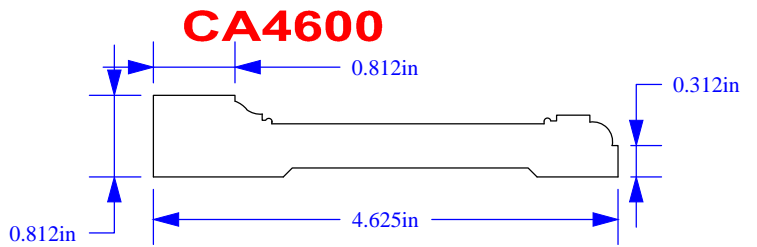
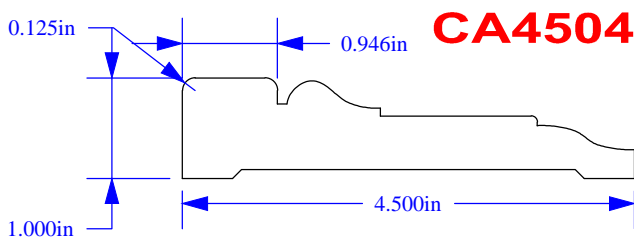
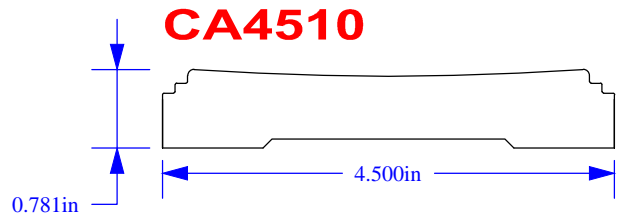
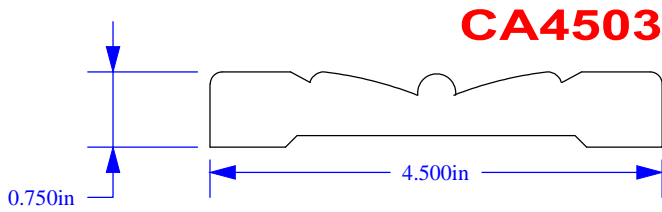
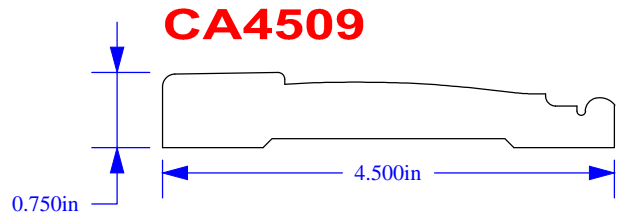
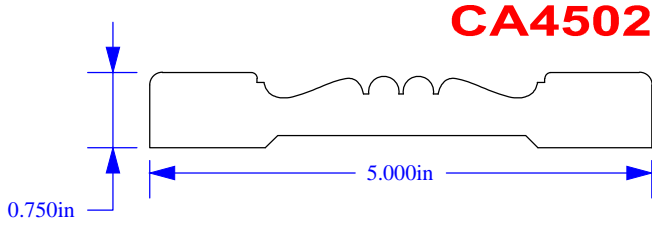
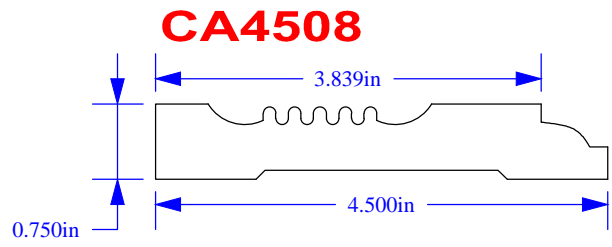
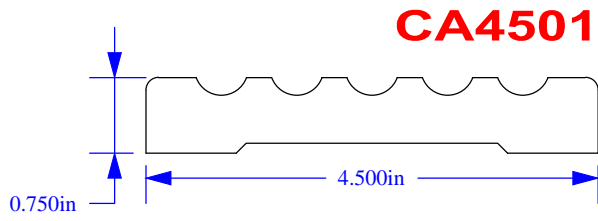

CA4751

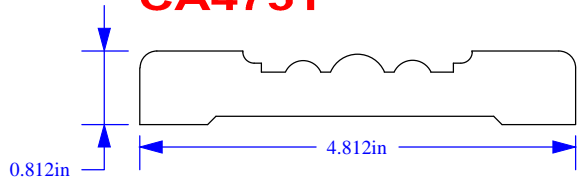

CA4752

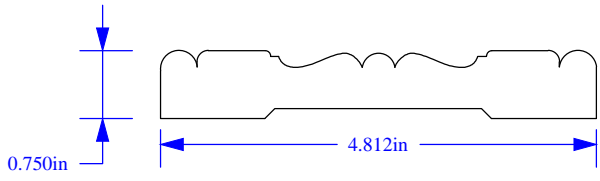

CA4753

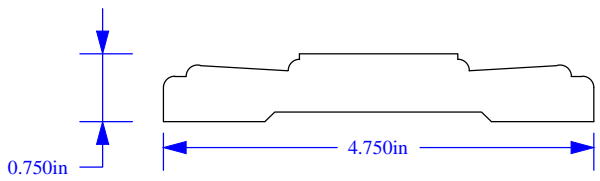

CA4800

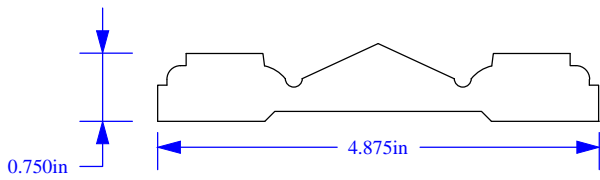

CA5001

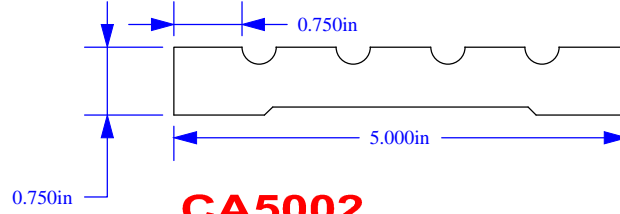

CA5002

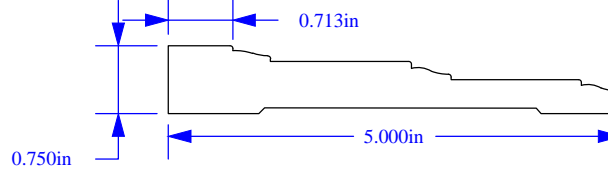

CA5003

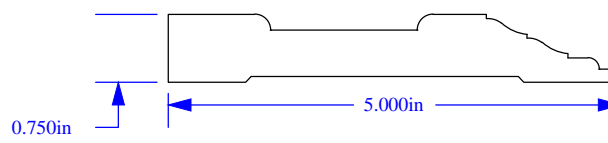

CA5501

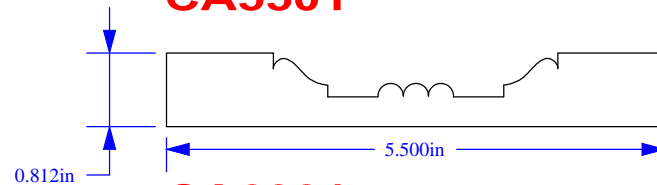

CA6001

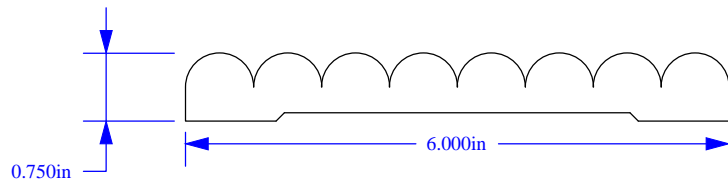

CA6002

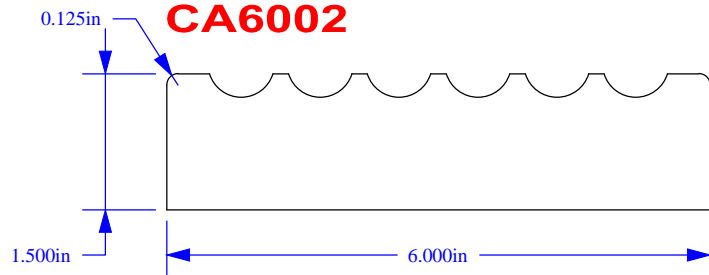

CA7000

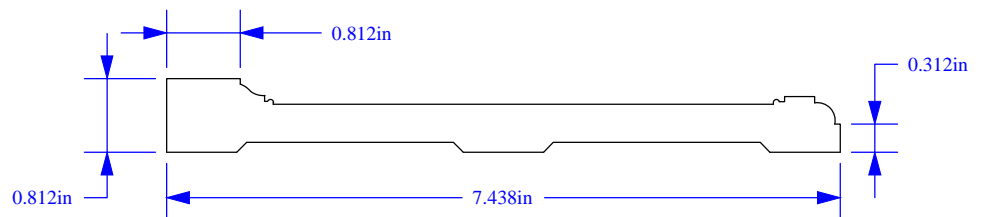

CH0751

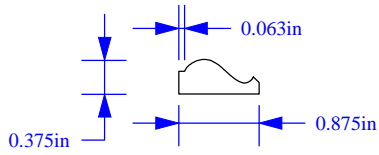

CH1751

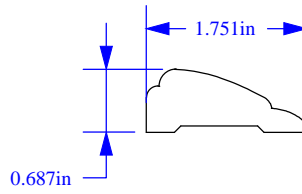

CH2005

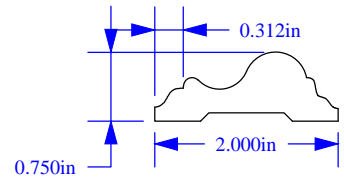

CH1001

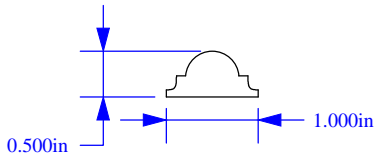

CH1752

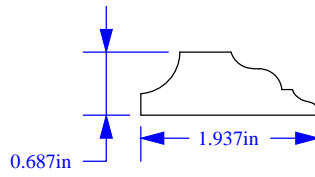

CH2006

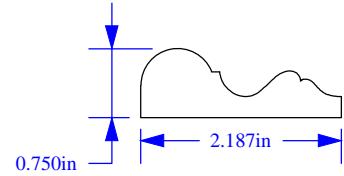

CH1002

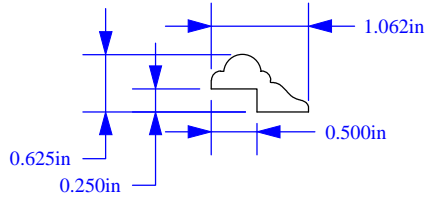

CH1753

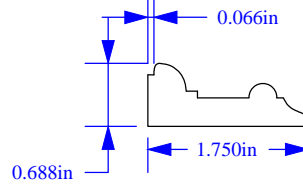

CH2007

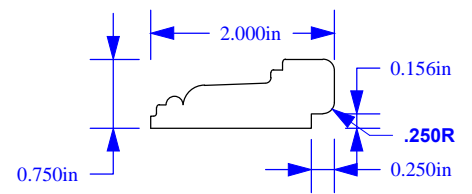

CH1251

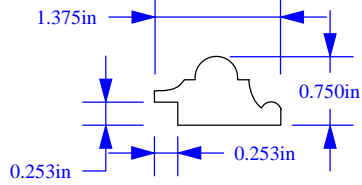

CH2001

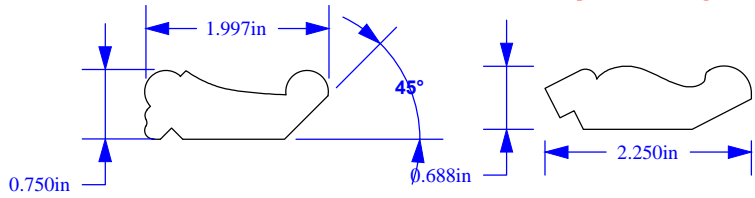

CH2251

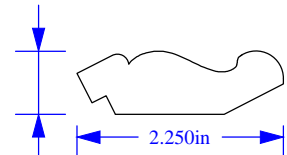

CH1252

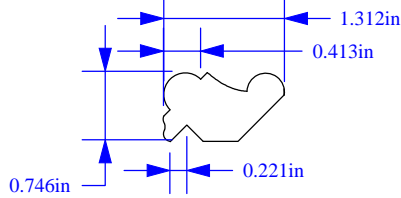

CH2002

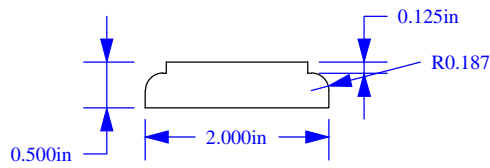

CH1501

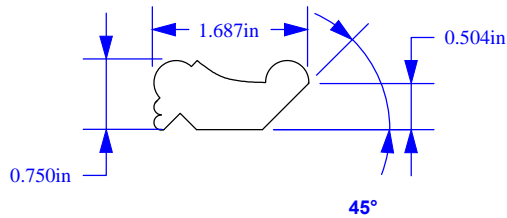

CH2003

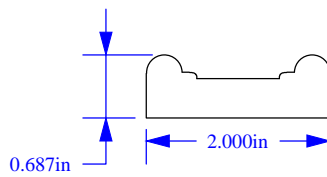

CH1504

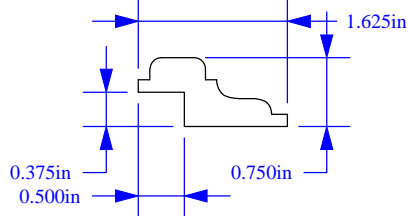

CH2004

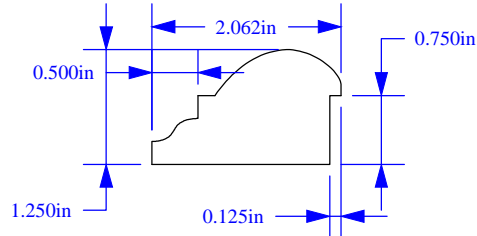

CH2253

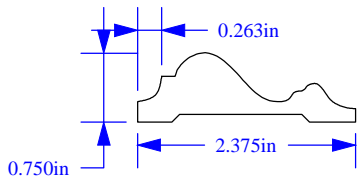

CH2506

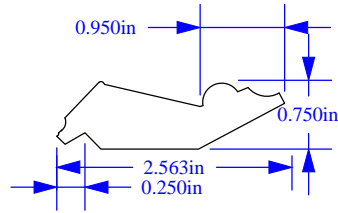

CH2254

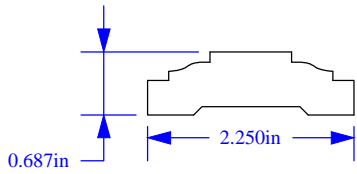

CH2751

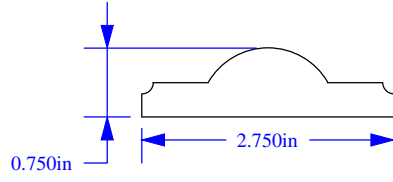

CH2255

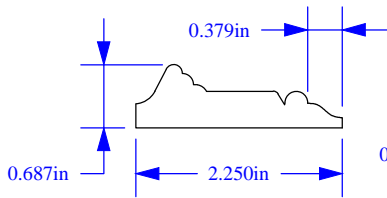

CH2752

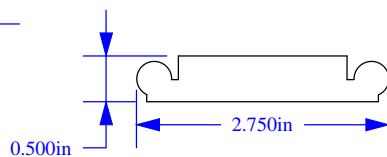

CH3001

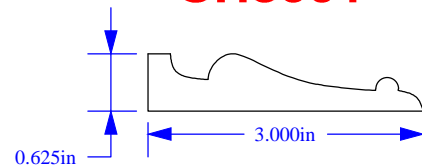

CH2501

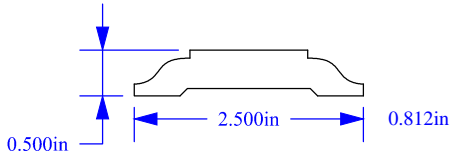

CH2753

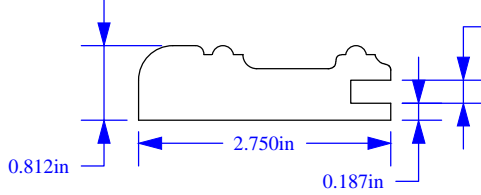

CH3003

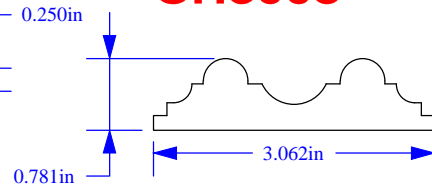

CH2503

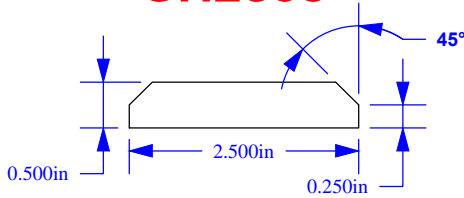

CH3251

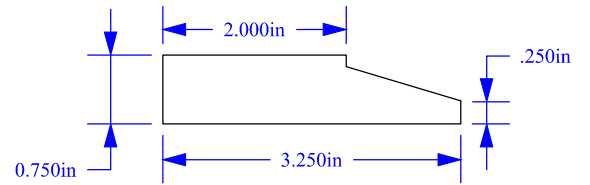

CH2504

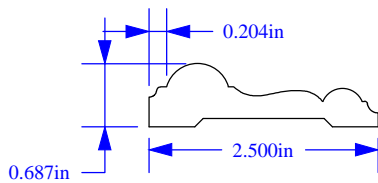

CH3252

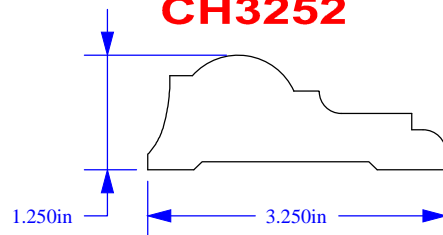

CH2505

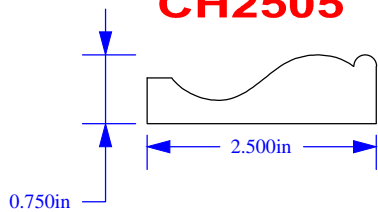

CH4001

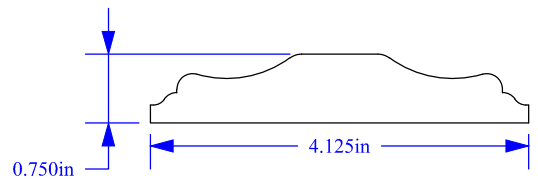

CH4501

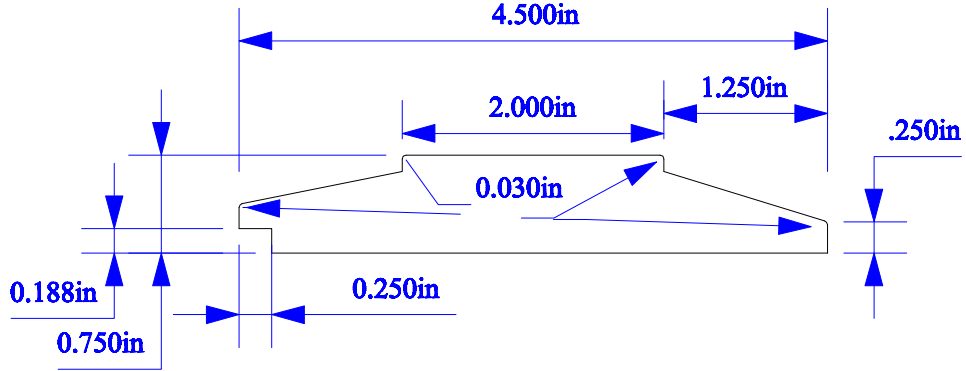

CH4751

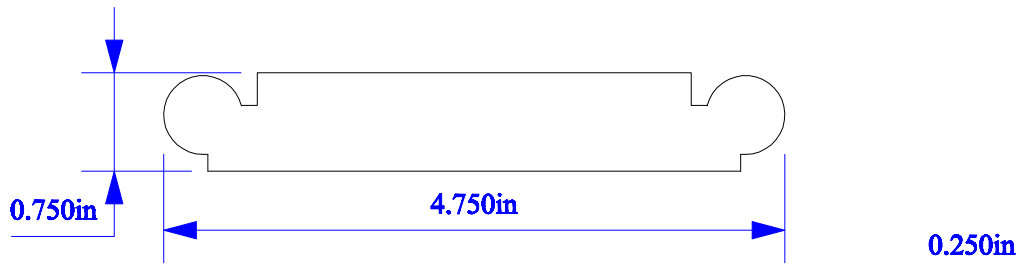

CH6001

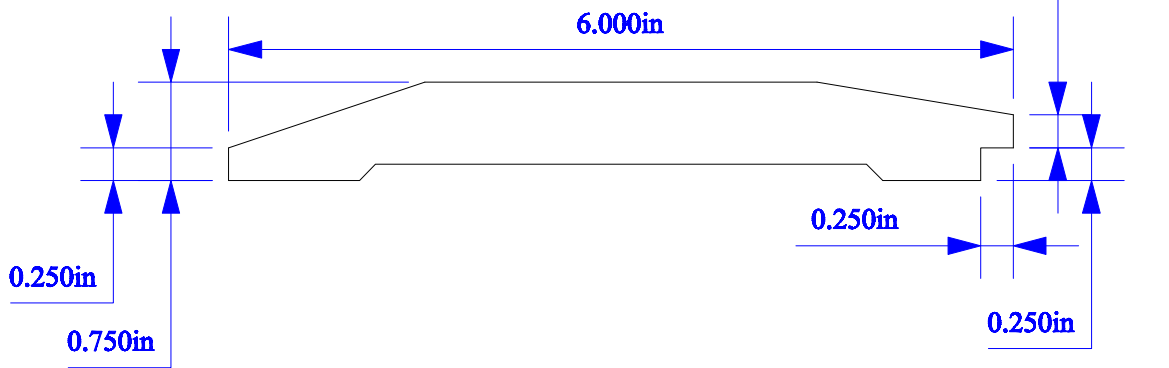

CR0501

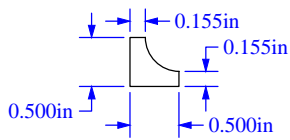

CR1751

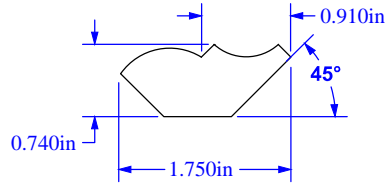

CR2001

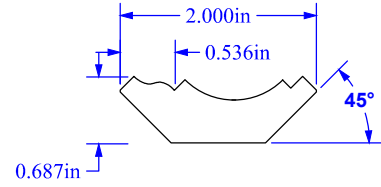

CR0751

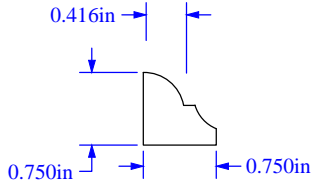

CR1752

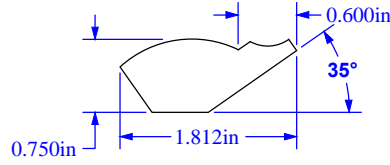

CR2002

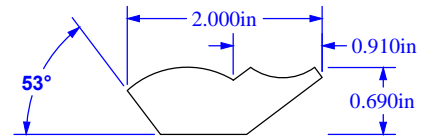

CR0752

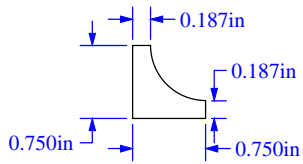

CR1754

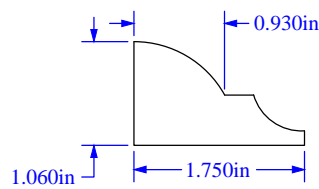

CR2003

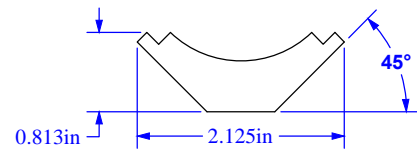

CR0753

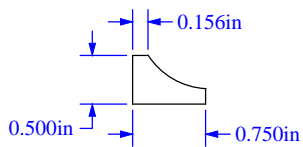

CR1755

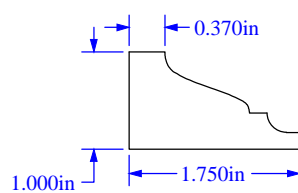

CR2251

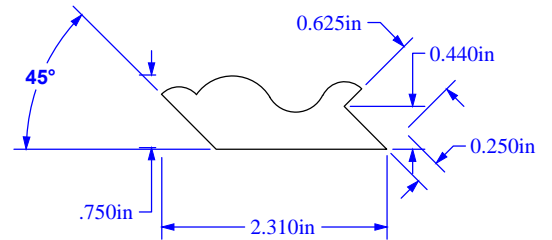

CR1251

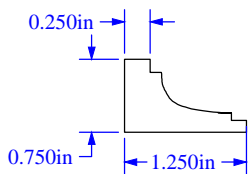

CR1501

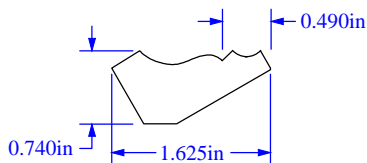

CR1502

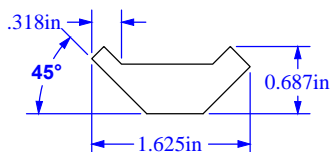

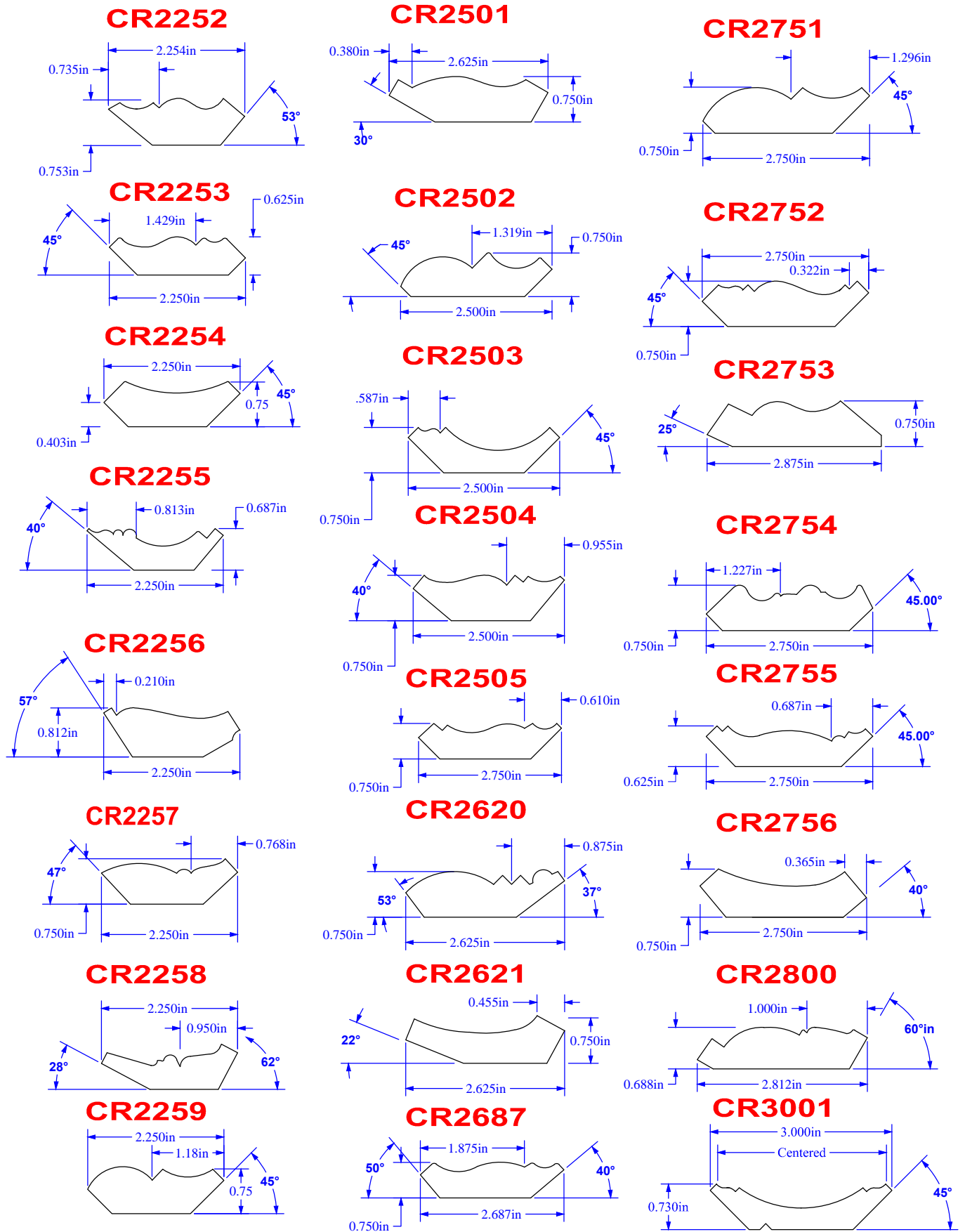

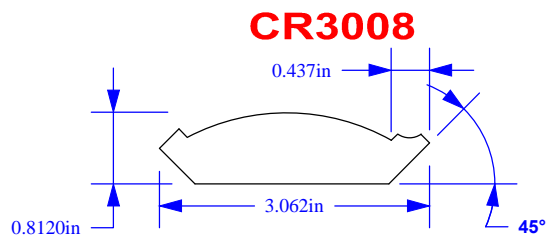
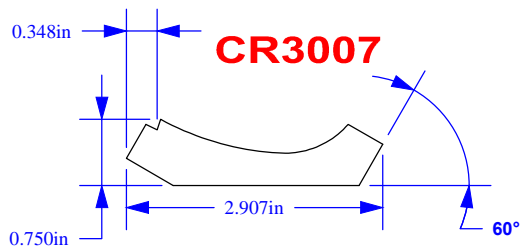
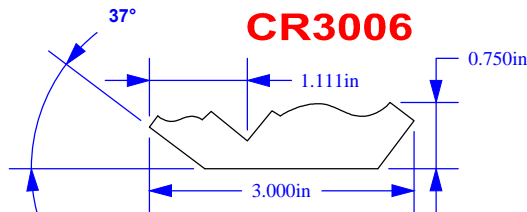
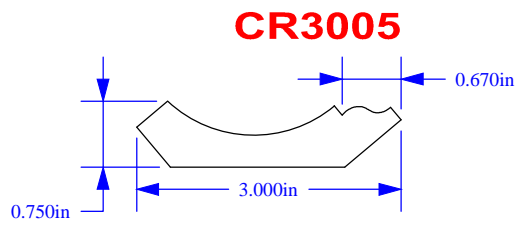
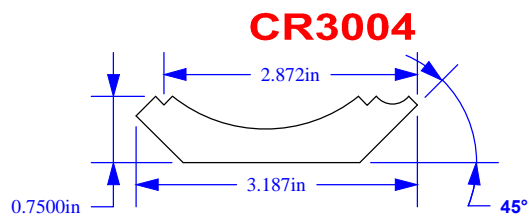
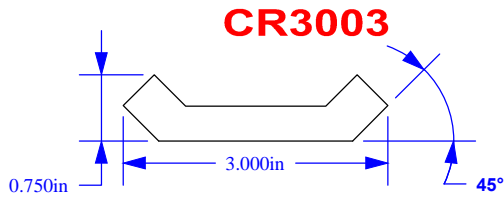
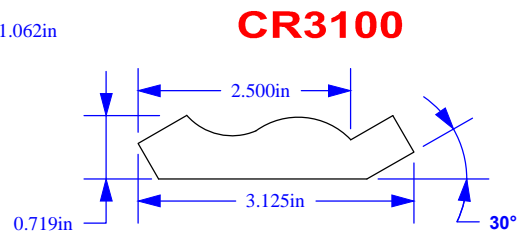
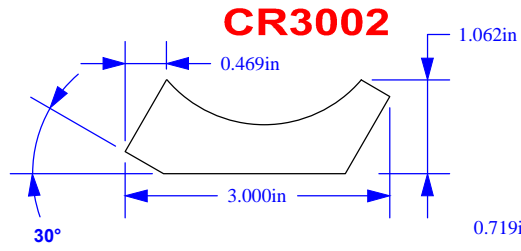

CR3251

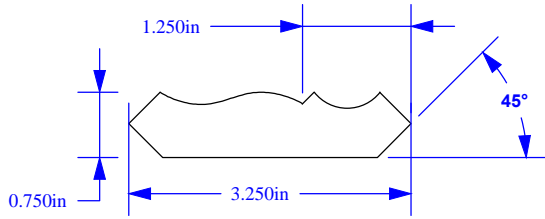

CR3252

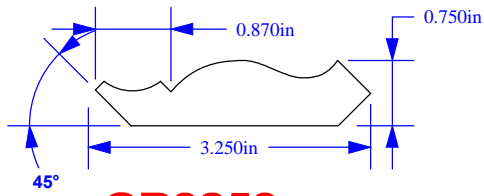

CR3253

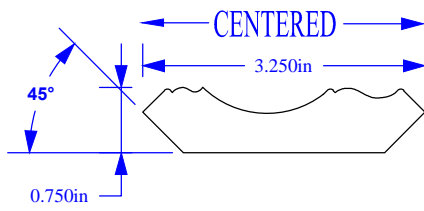

CR3254

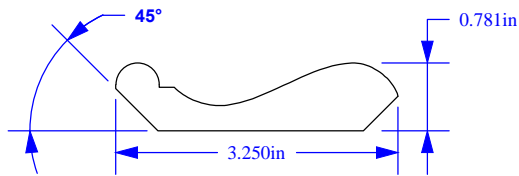

CR3255

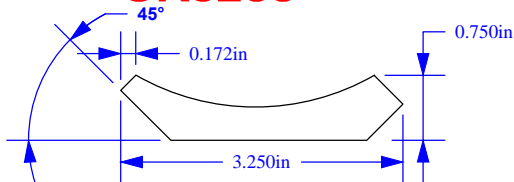

CR3256

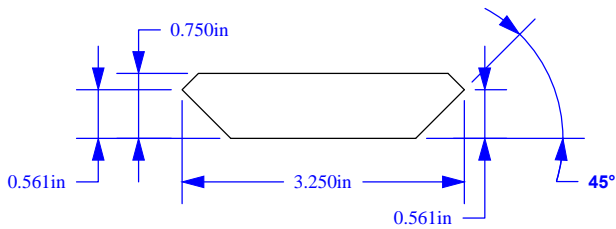

CR3257

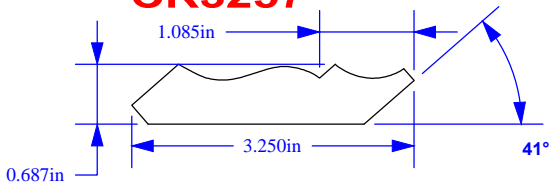

CR3258

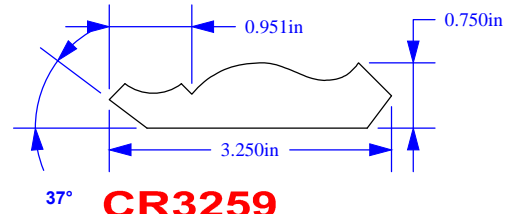

CR3259

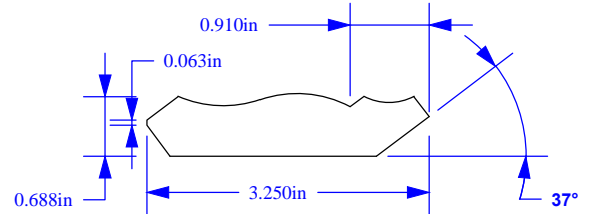

CR3260

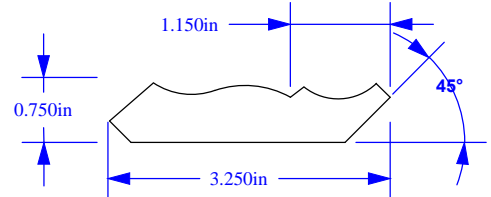

CR3301

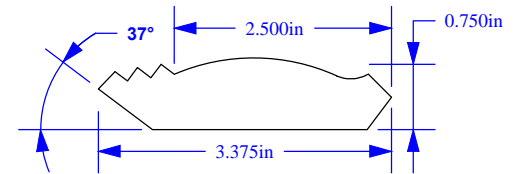

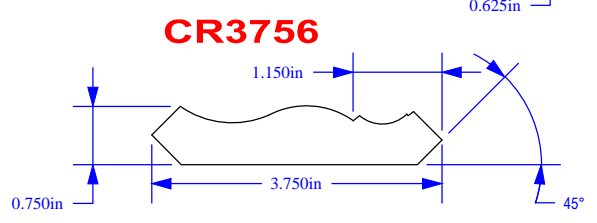
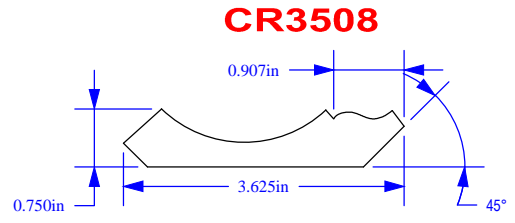
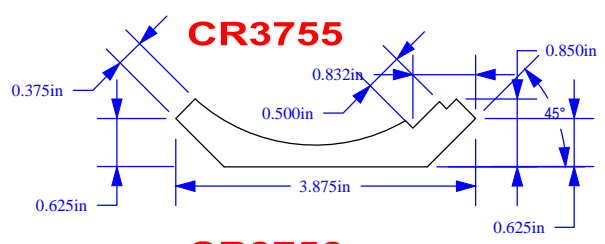
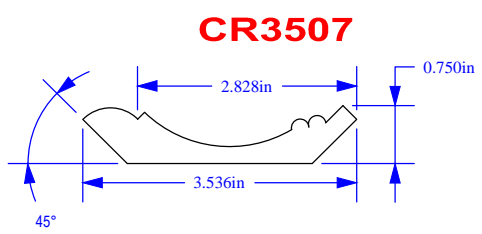
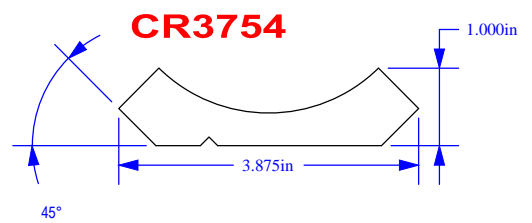
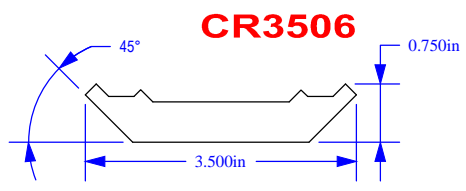
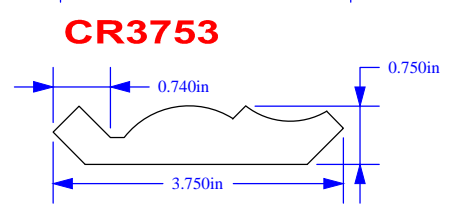
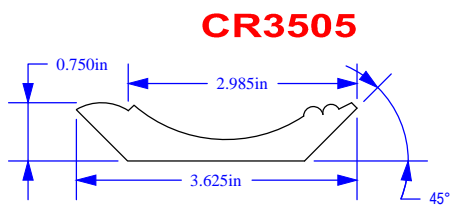
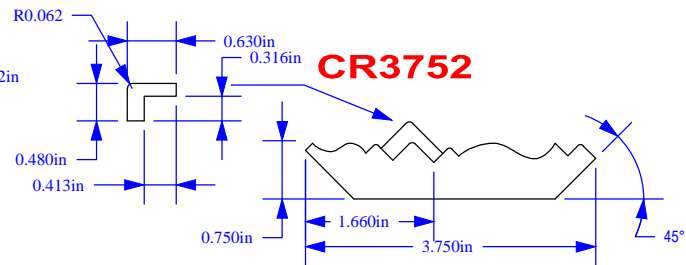
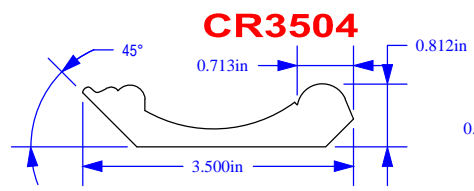
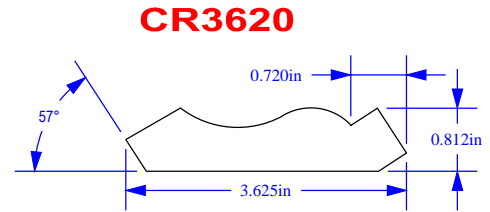
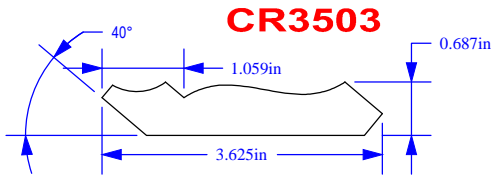
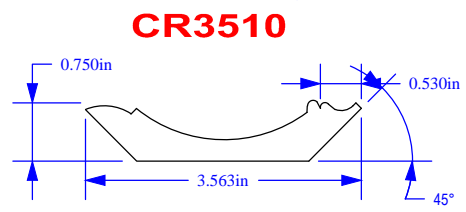
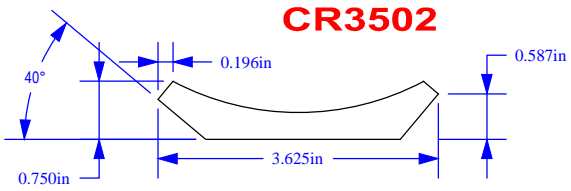
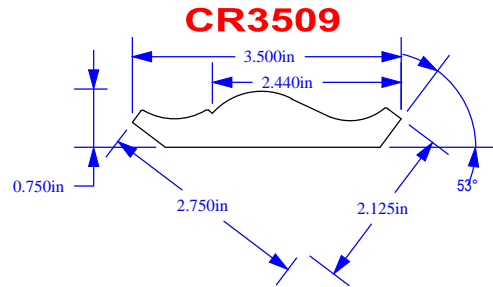
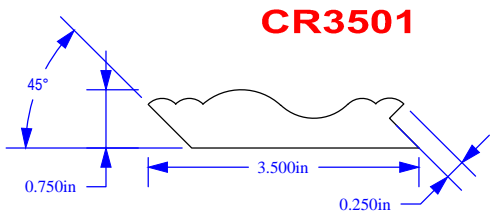

CR4001

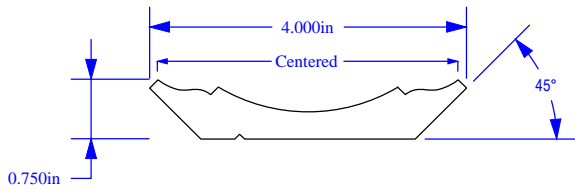

CR4009

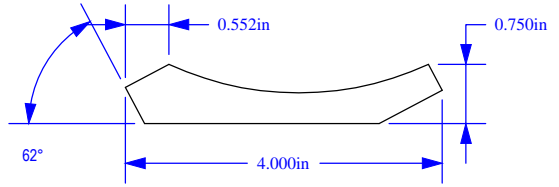

CR4002

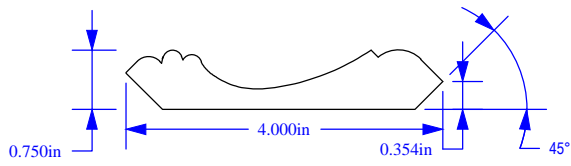

CR4010

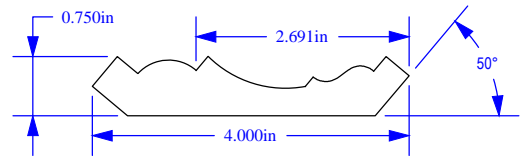

CR4003

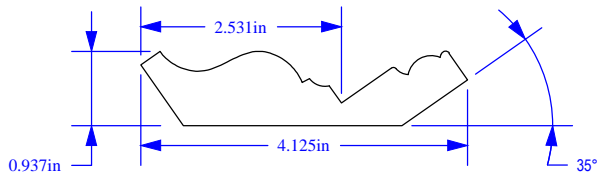

CR4011

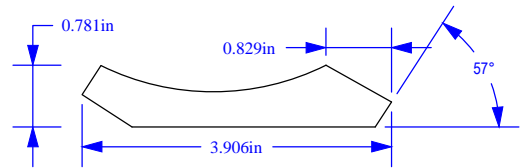

CR4004

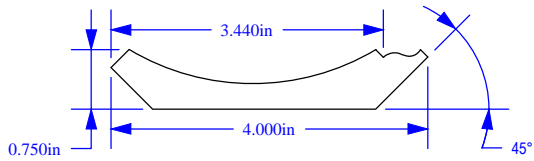

CR4005

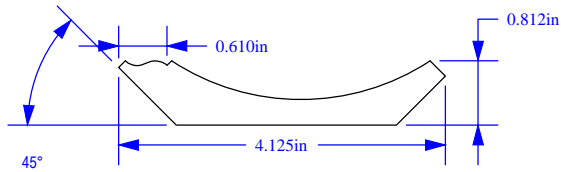

CR4006

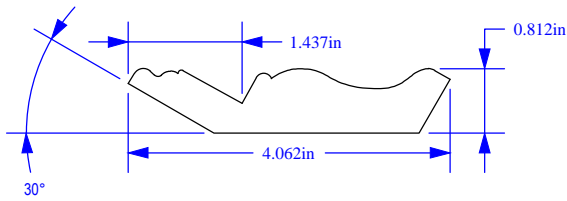

CR4007

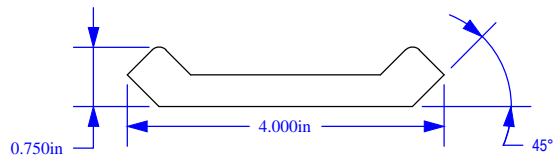

CR4008

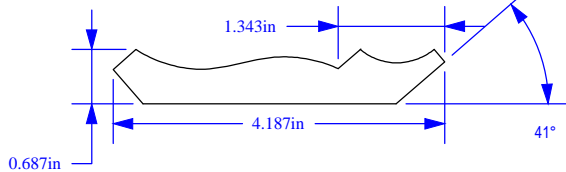

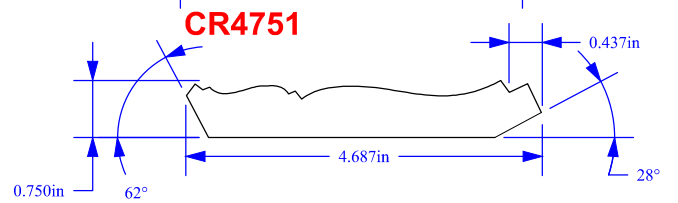
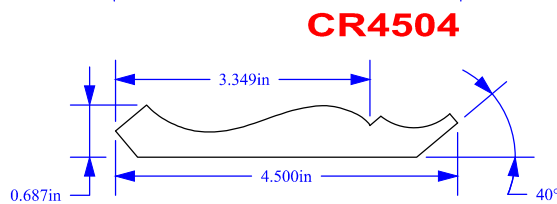
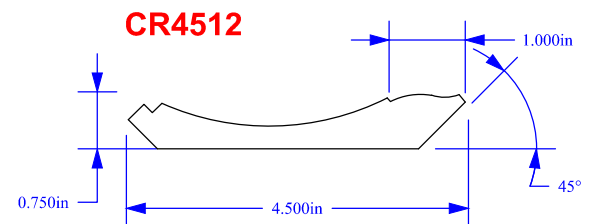
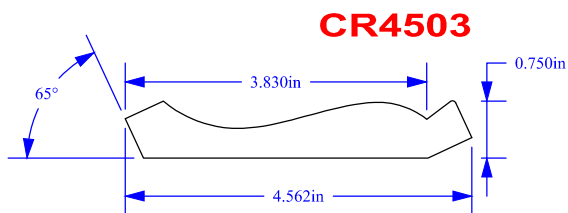
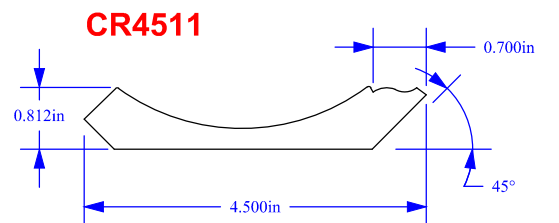
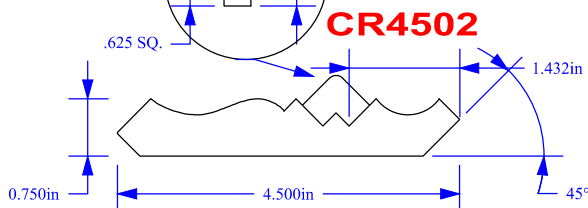
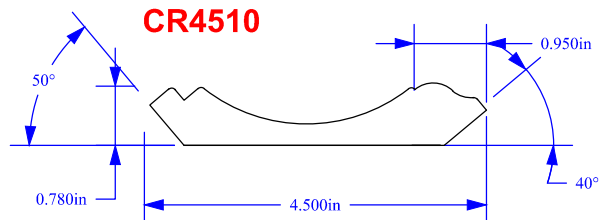
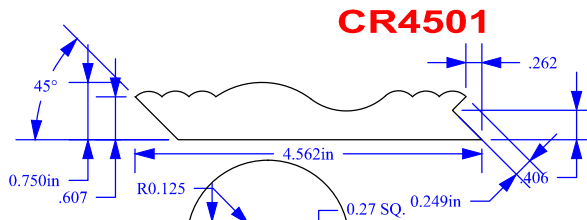
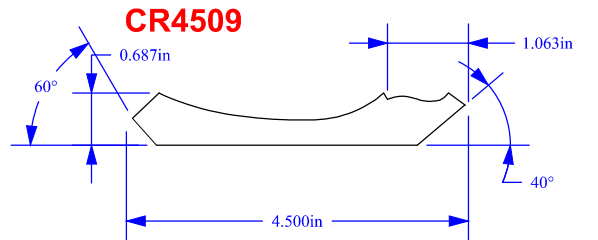
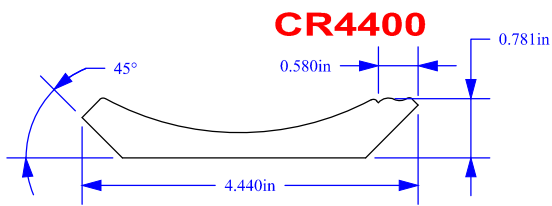
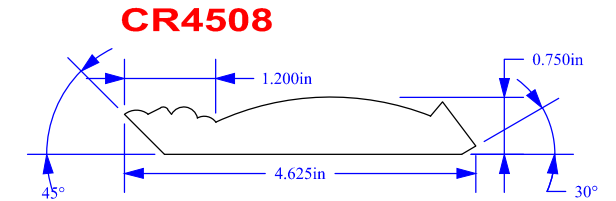
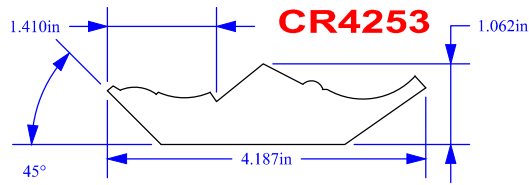
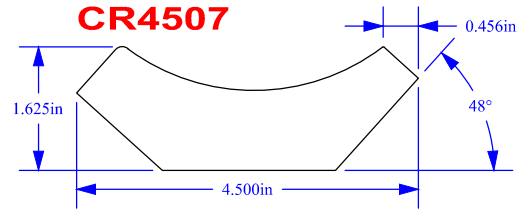
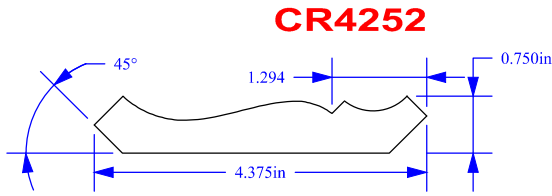
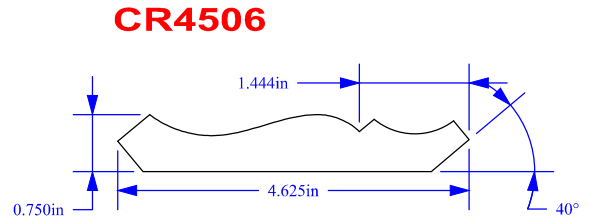
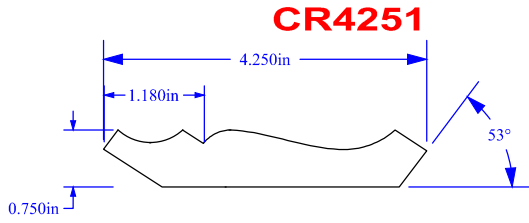

CR5001

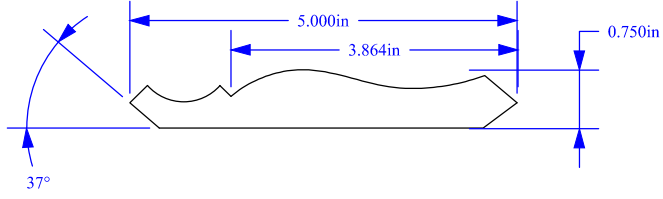

CR5251

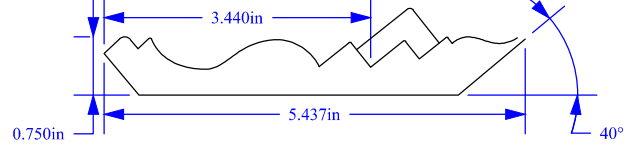

CR5002

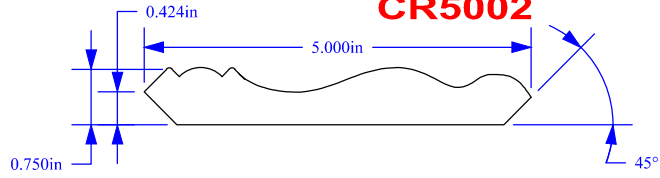

CR5252

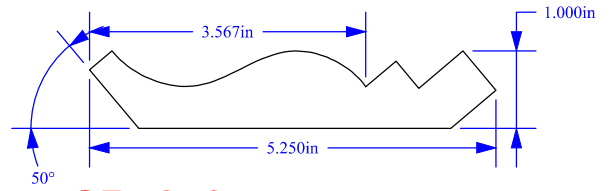

CR5003

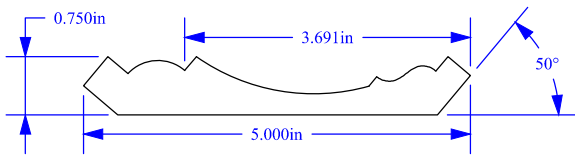

CR5253

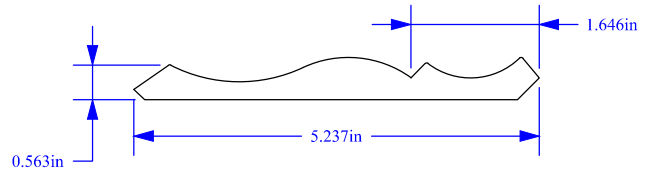

CR5004

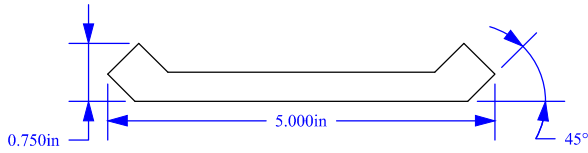

CR5300

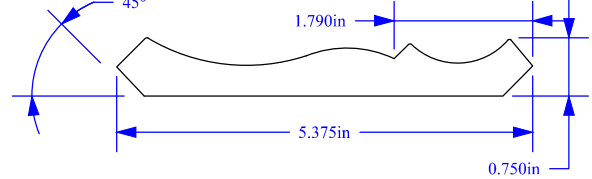

CR5005

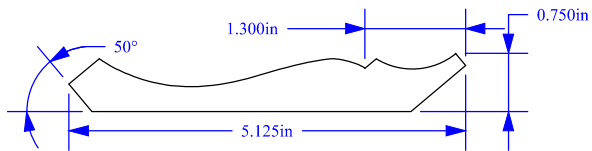

CR5006

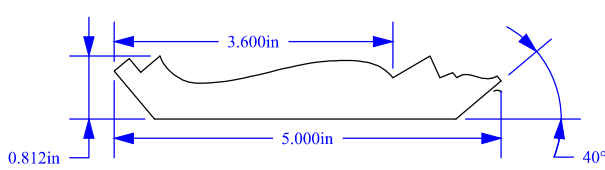

CR5007

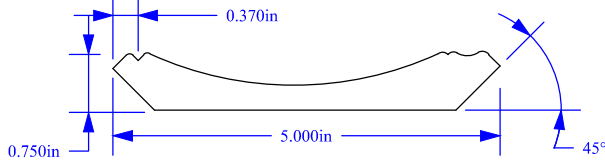

CR5008

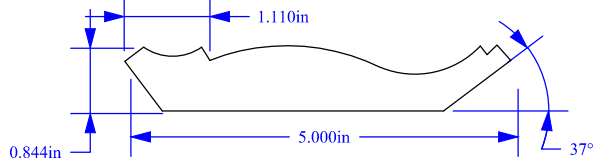

CR5501

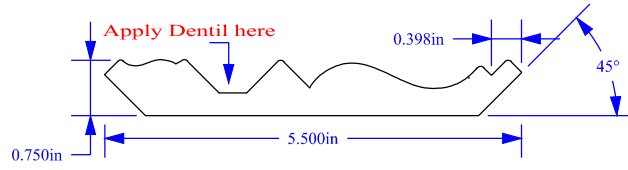

CR5620

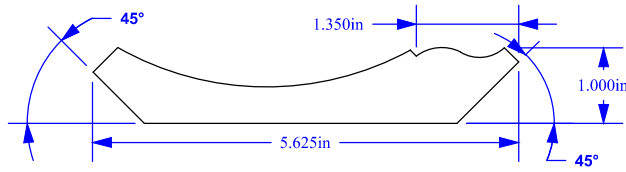

CR5751

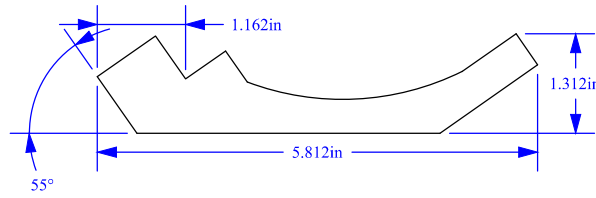

CR5752

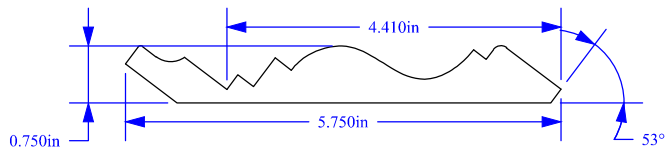

CR5752 TEETH

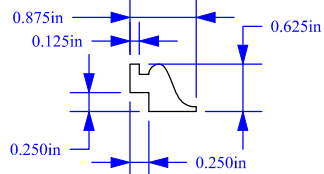

CR5753

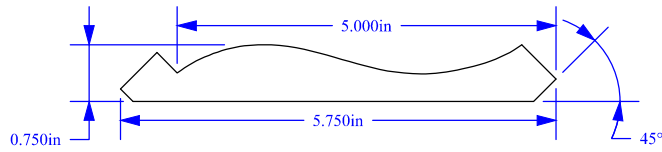

CR6001

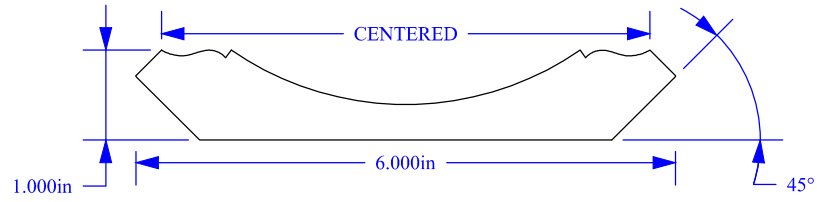

CR6002

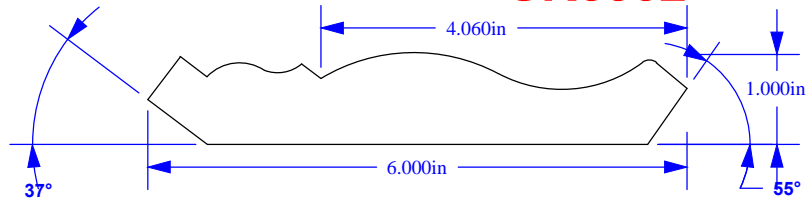

CR6003

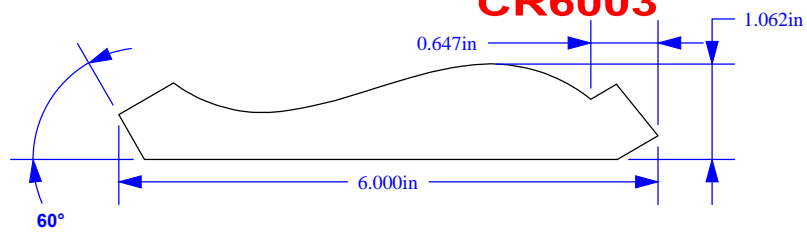

CR6004

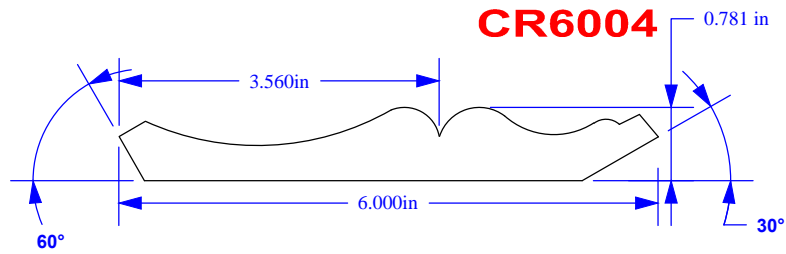

CR6125

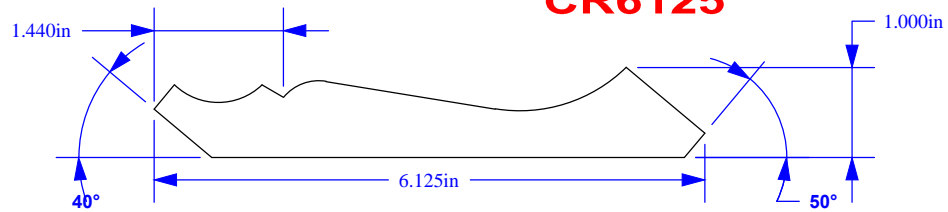

CR6251

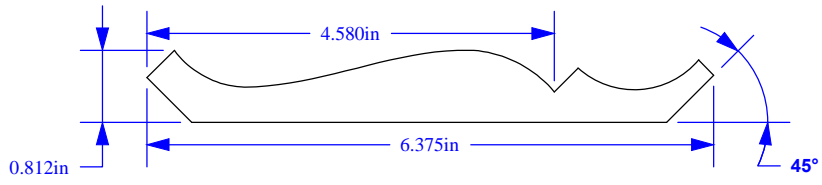

CR6252

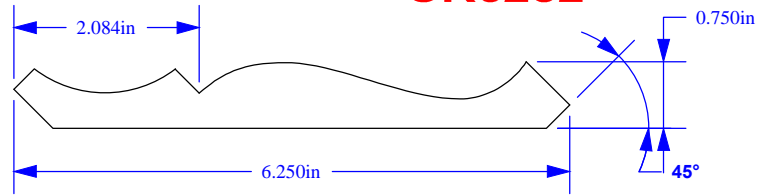

CR6300

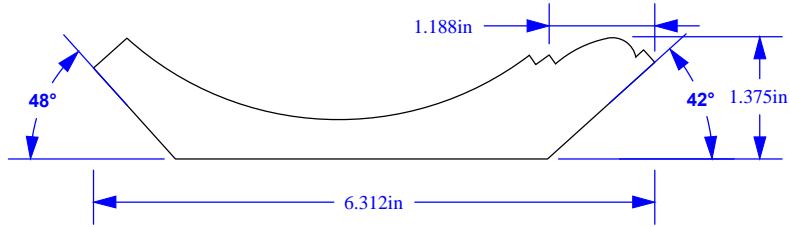

CR6501

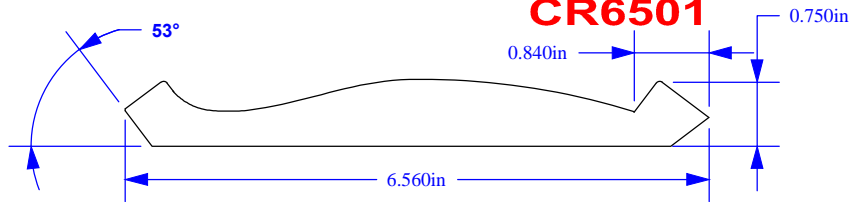

CR6751

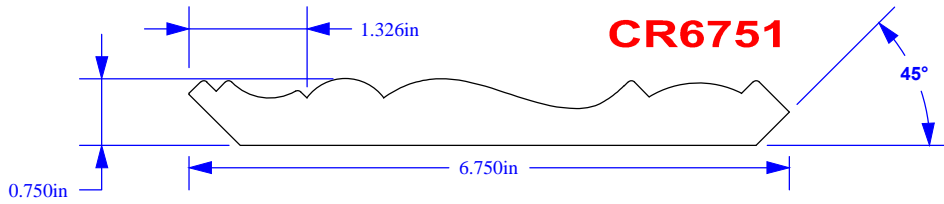

CR7001

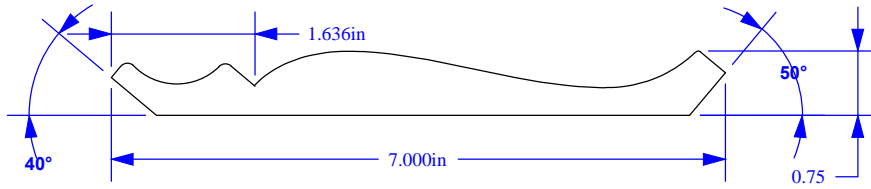

CR7002

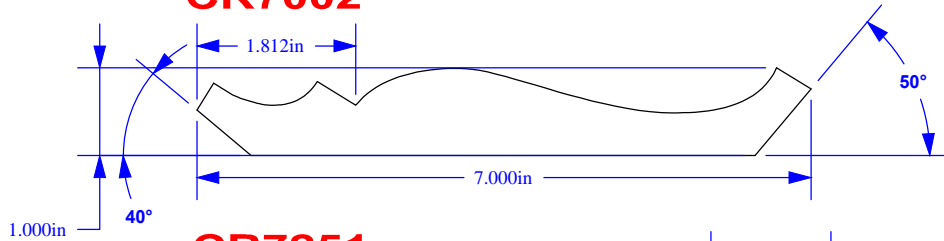

CR7251

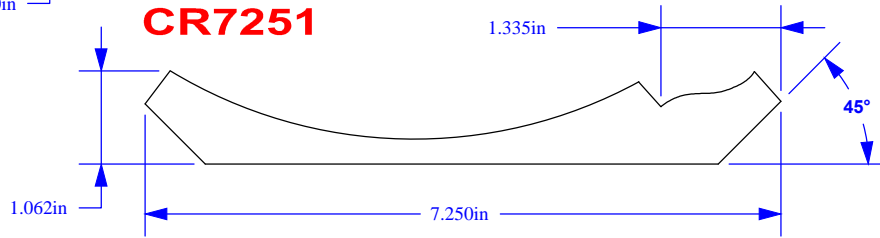

CR7751

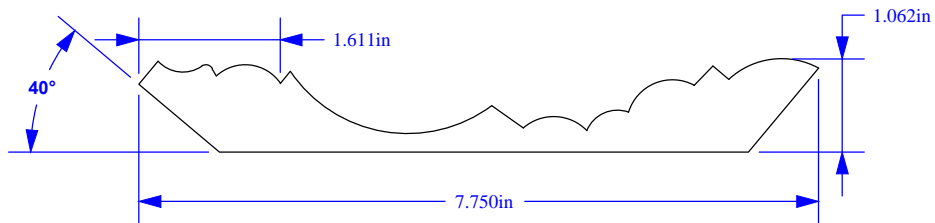

CR8001

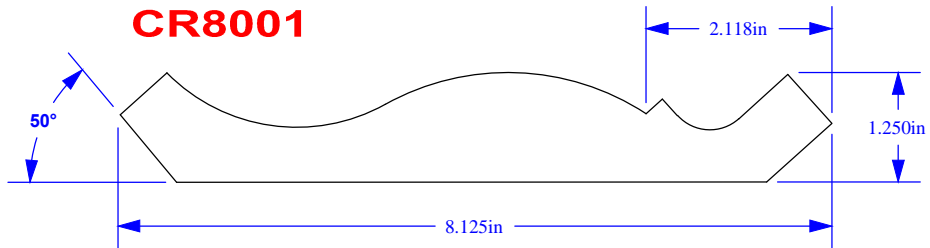

CR8002

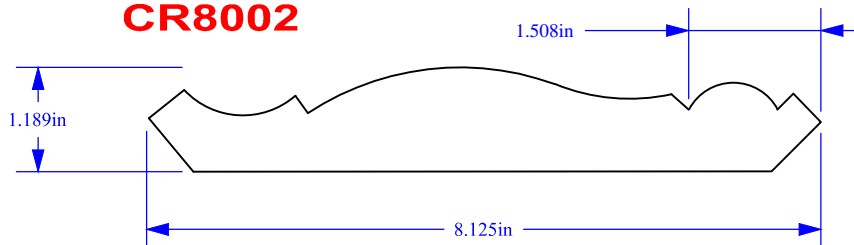

HR2251

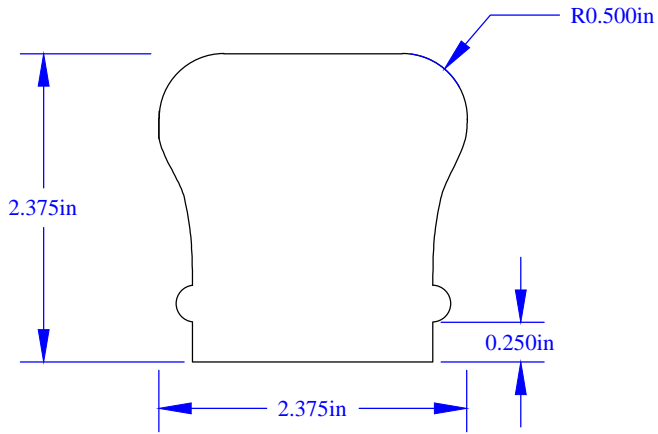

HR2501

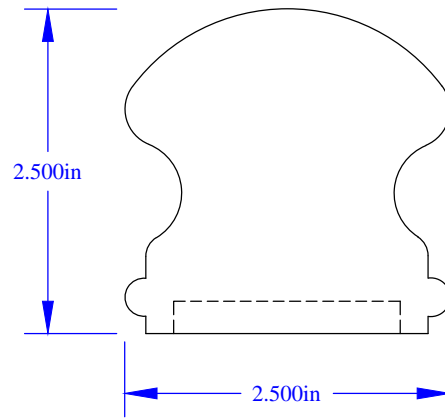

HR2252

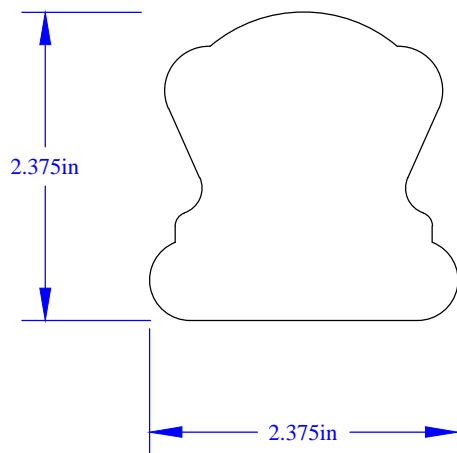

HR2502

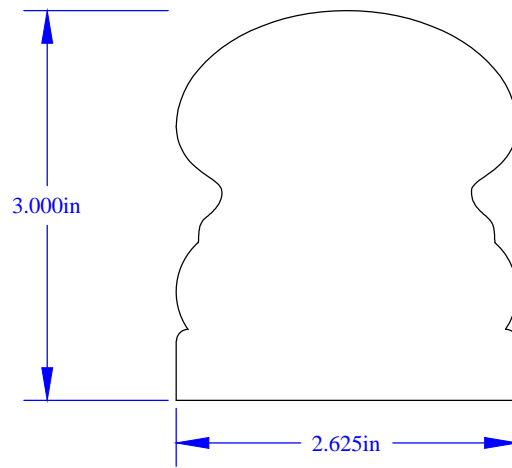

HR2258

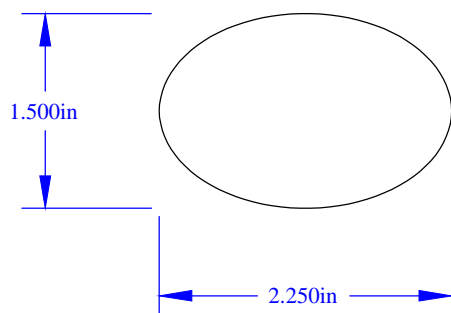

HR2503

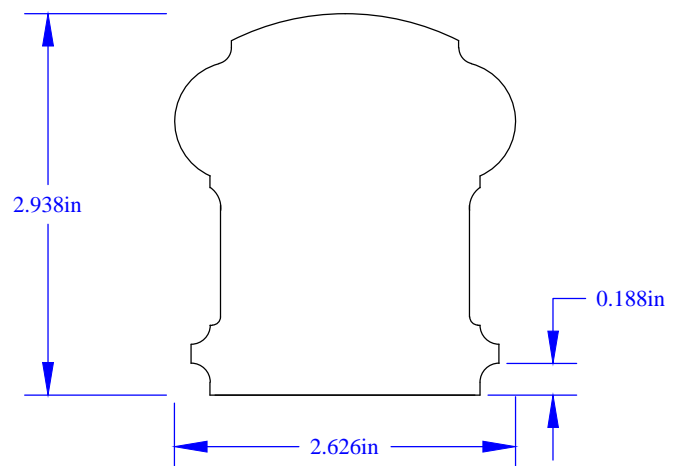

HR2253

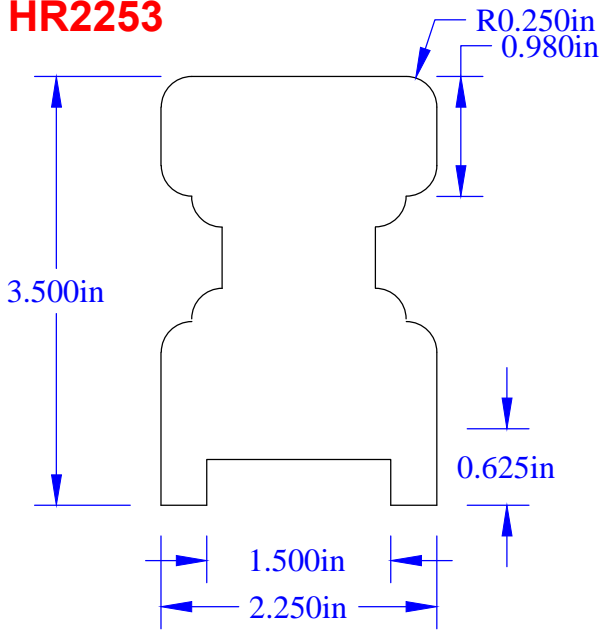

1751

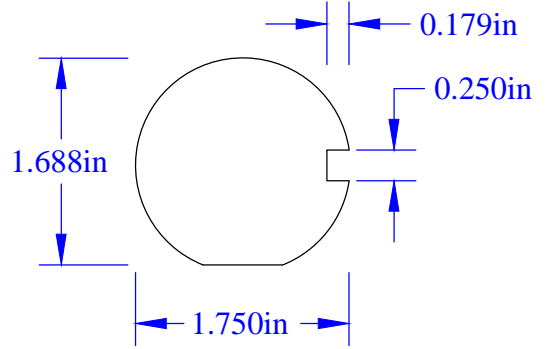

HR2254

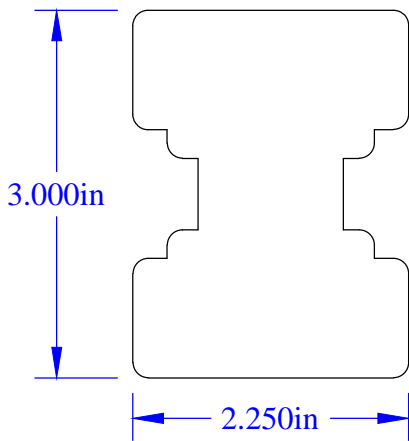

HR3505

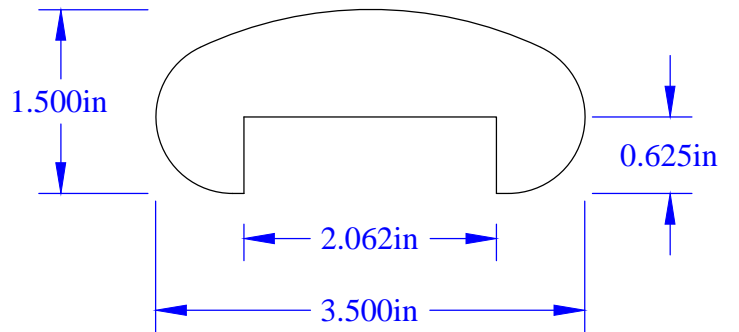

HR2002

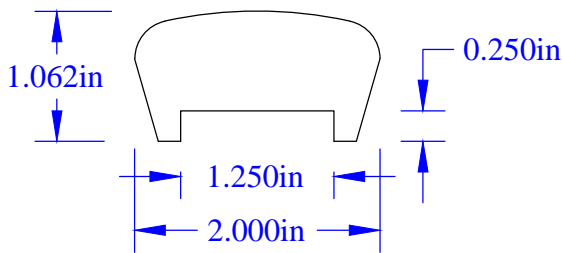

HR3003

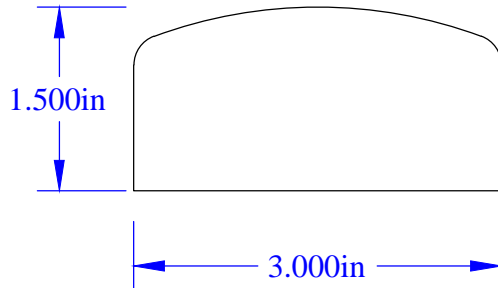

HR2003

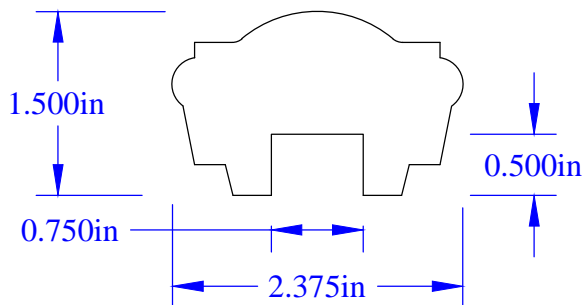

HR3004

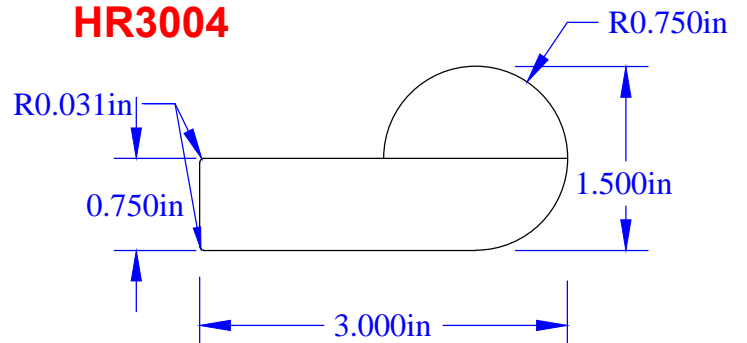

HR2751

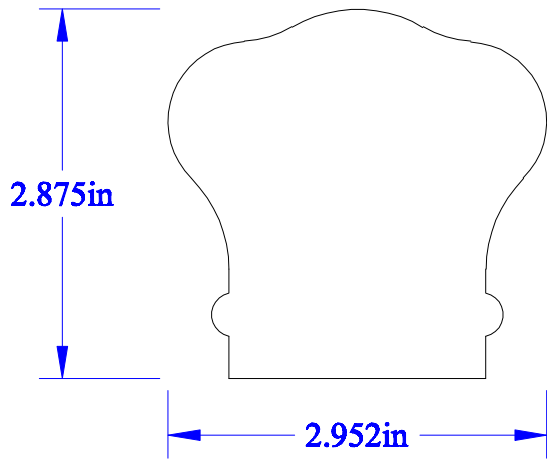

HR3501

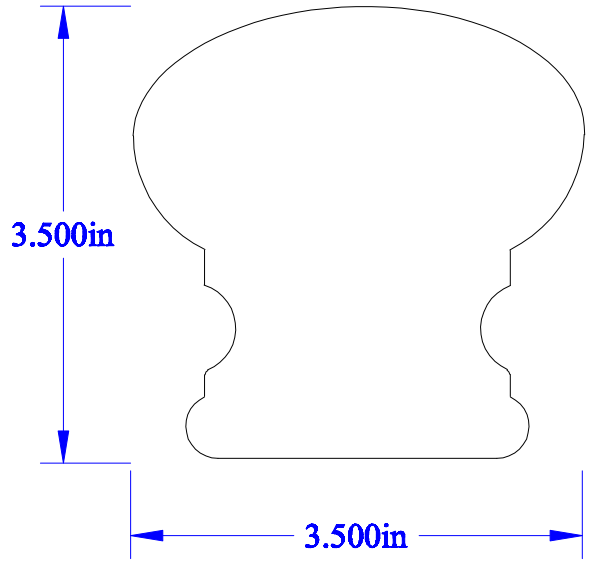

HR3001

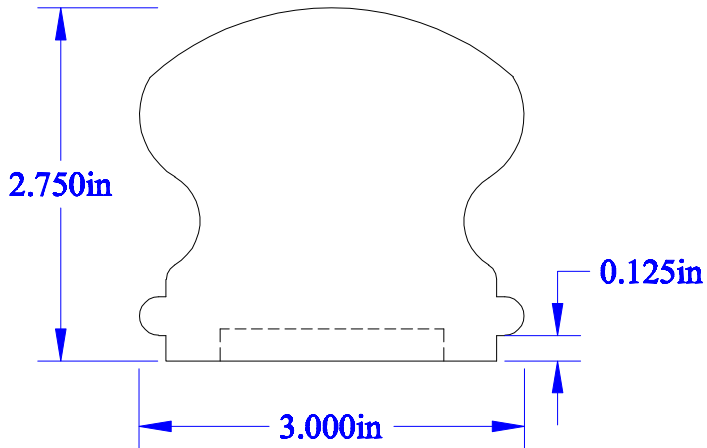

HR3502

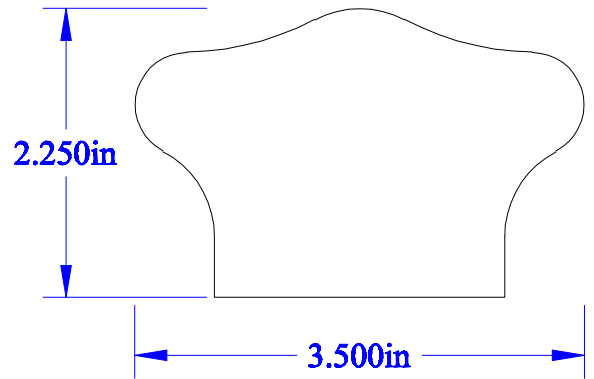

HR3751

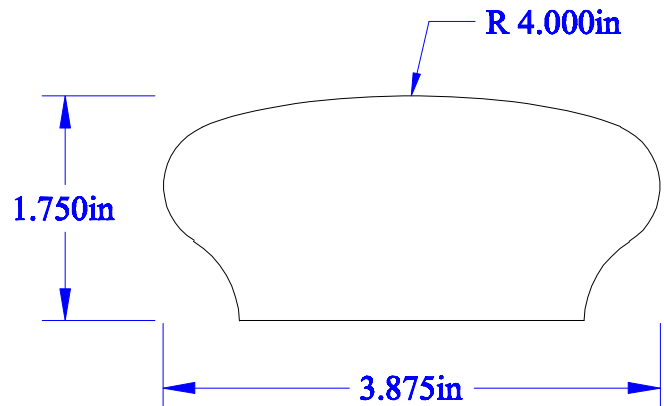

HR5501

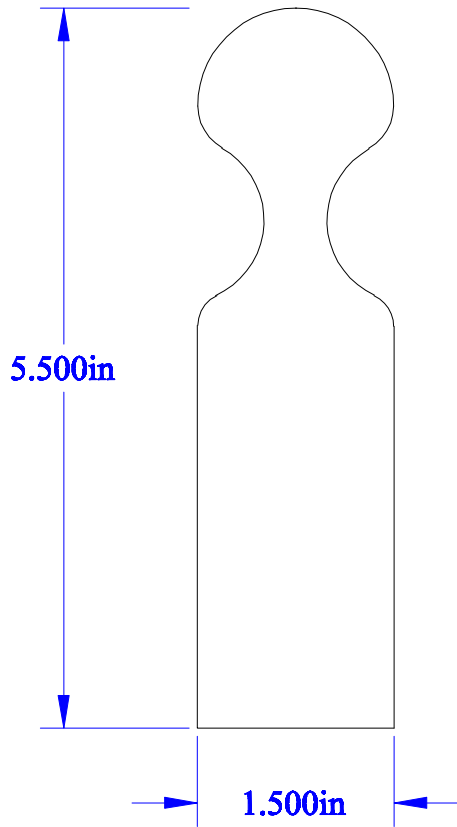

HR5502

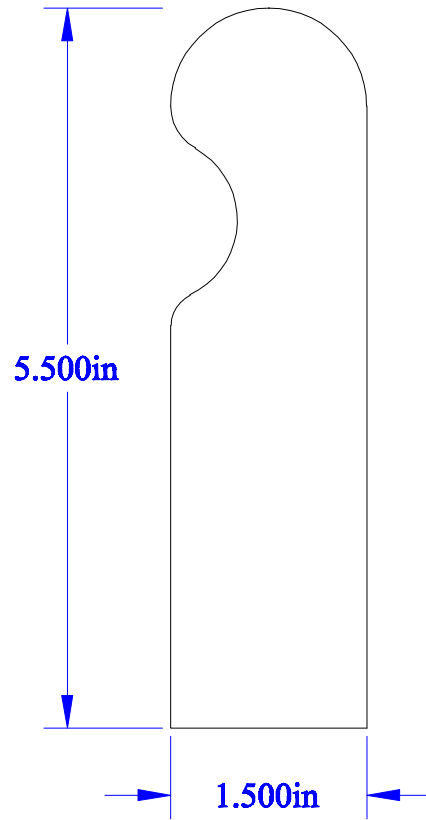

HR3503

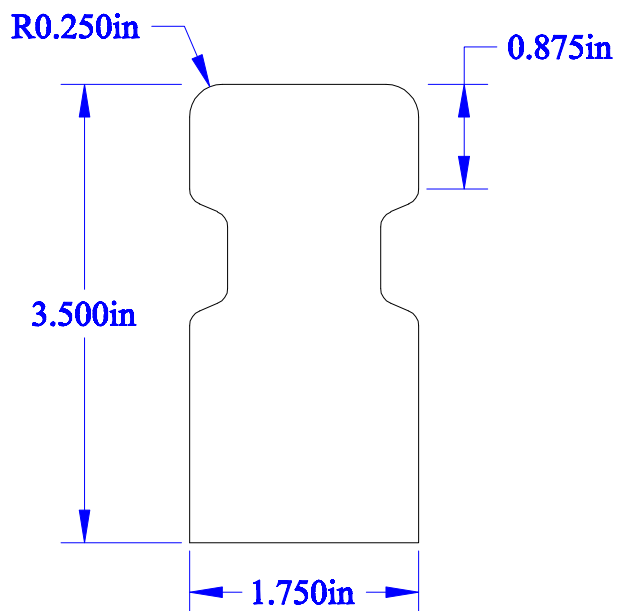

HR3504

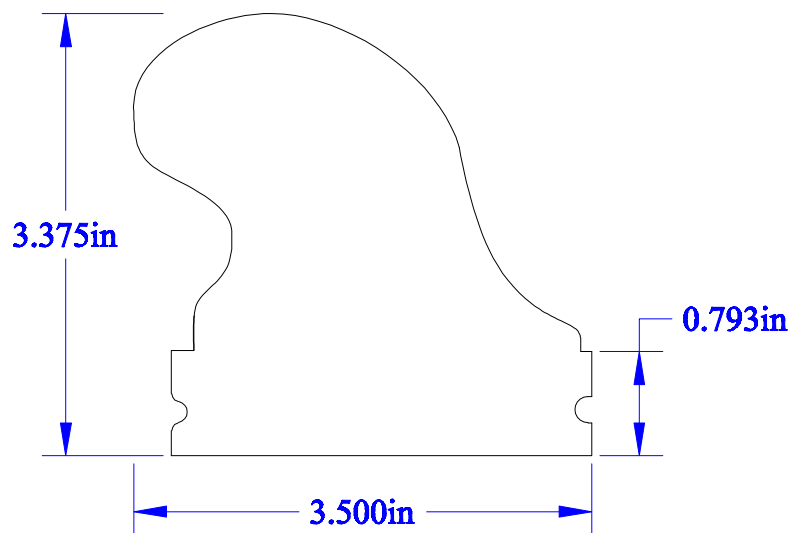

MS0501

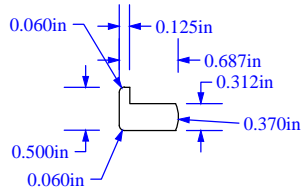

MS0510

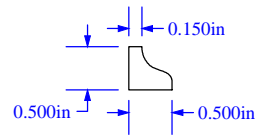

MS0502

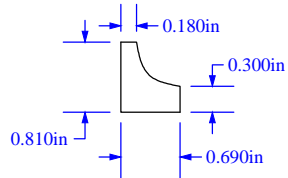

MS0511

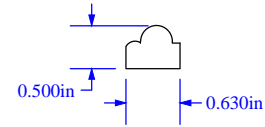

MS0504

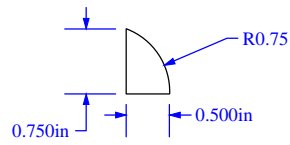

MS0512

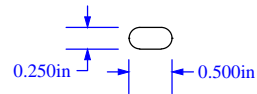

MS0505

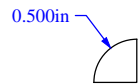

MS0513

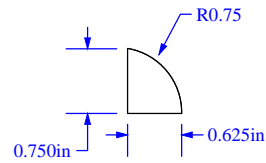

MS0507

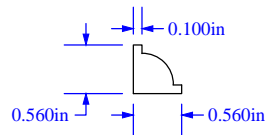

MS0514

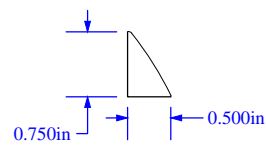

MS0508

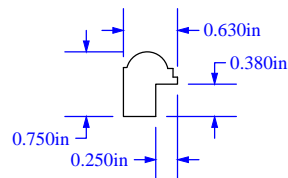

MS0620

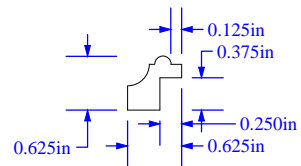

MS0509

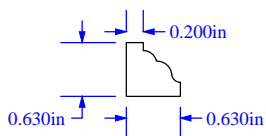

MS0751

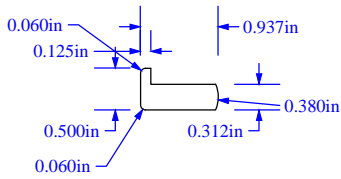

MS0759

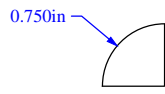

MS0769

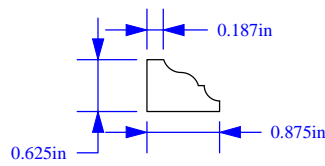

MS0777

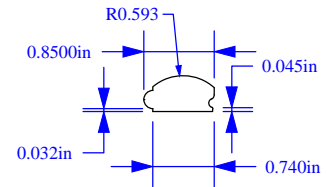

MS0752

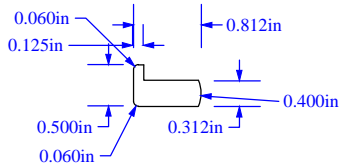

MS0760

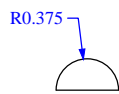

MS0770

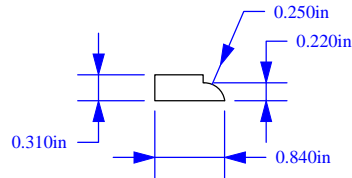

MS0753

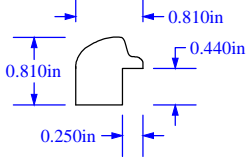

MS0763

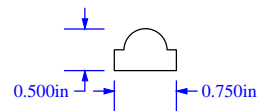

MS0771

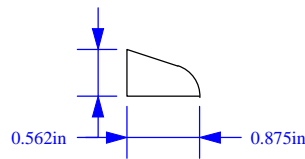

MS0754

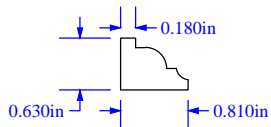

MS0764

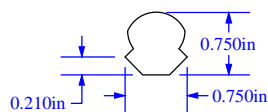

MS0772

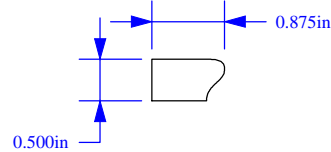

MS0755

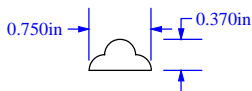

MS0765

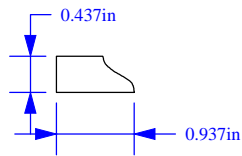

MS0773

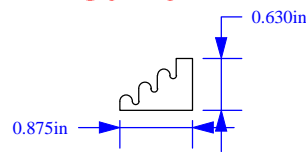

MS0756

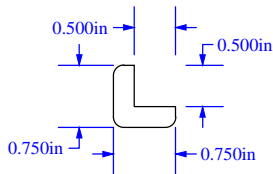

MS0766

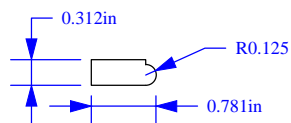

MS0774

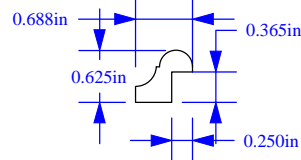

MS0757

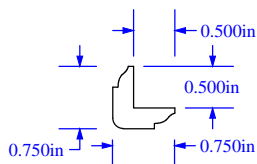

MS0767

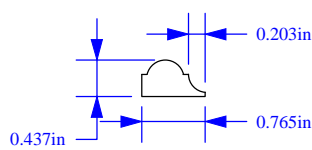

MS0775

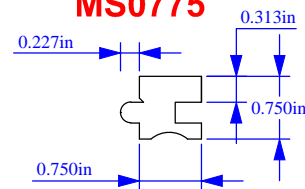

MS0758

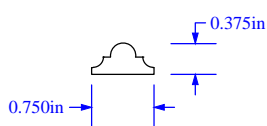

MS0768

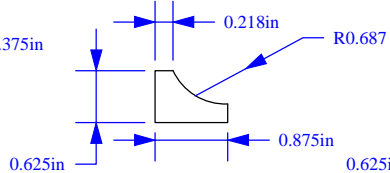

MS0776

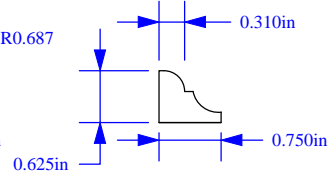

MS1001

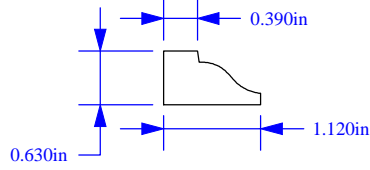

MS1008

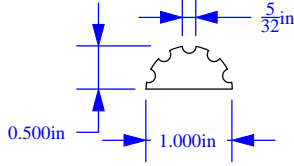

MS1016

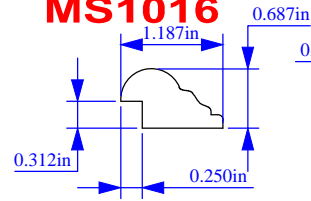

MS1023

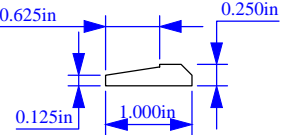

MS1002

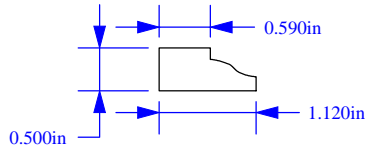

MS1010

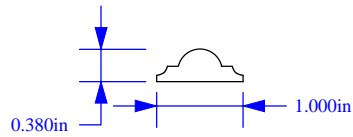

MS1017

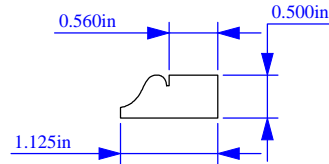

MS1003

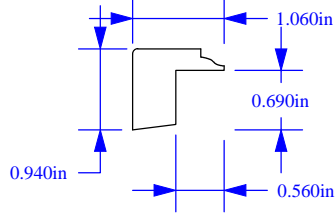

MS1011

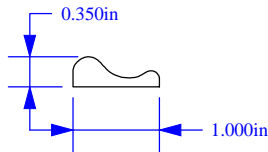

MS1018

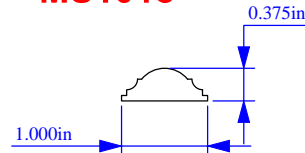

MS1004

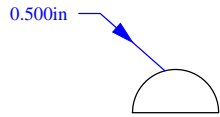

MS1012

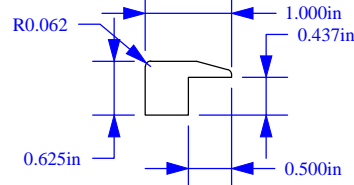

MS1019

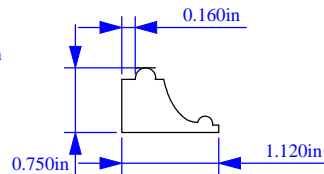

MS1005

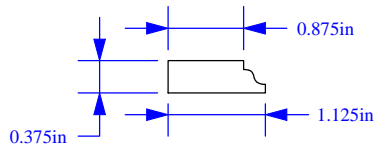

MS1013

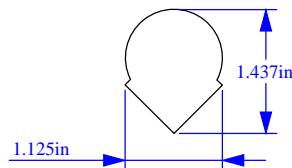

MS1020

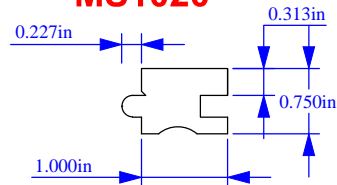

MS1006

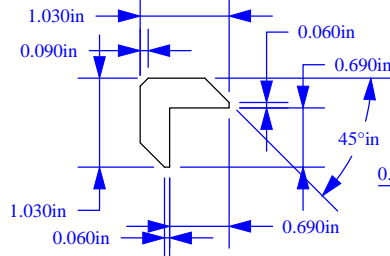

MS1014

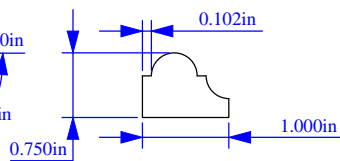

MS1021

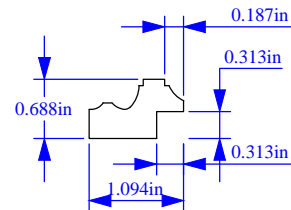

MS1007

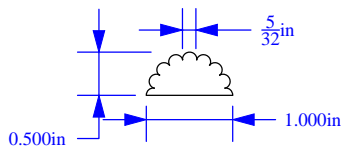

MS1015

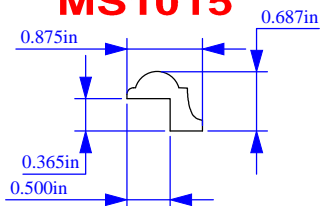

MS1022

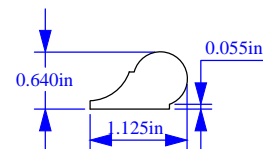

MS1251

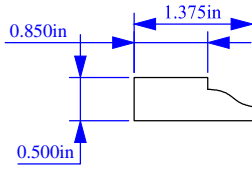

MS1258

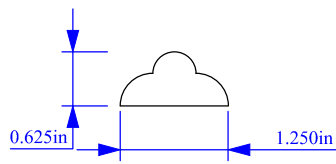

MS1267

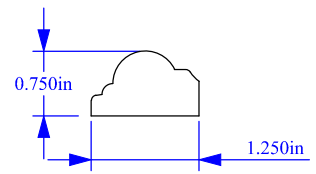

MS1252

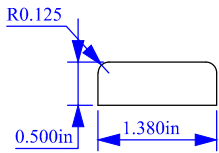

MS1259

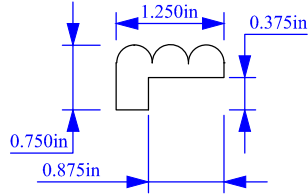

MS1253

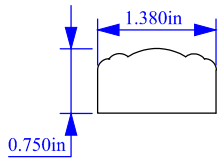

MS1261

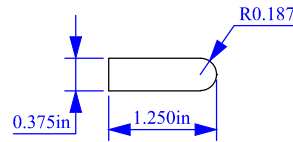

MS1254

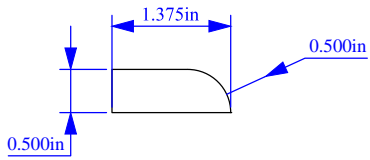

MS1263

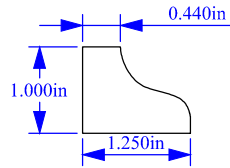

MS1255

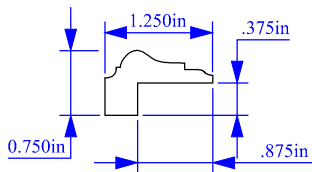

MS1264

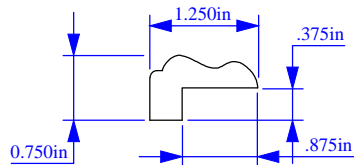

MS1256

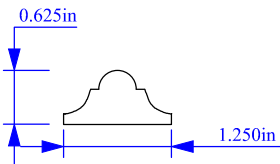

MS1265

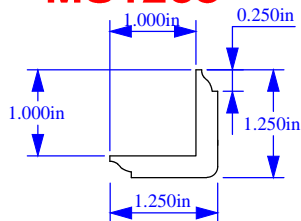

MS1257

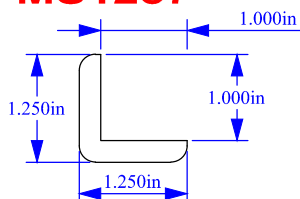

MS1266

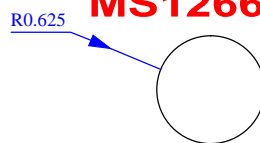

MS1269

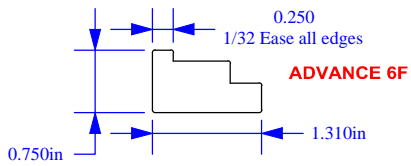

MS1283

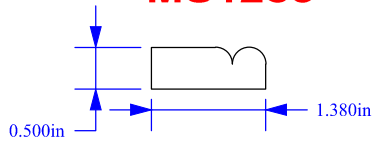

MS1301

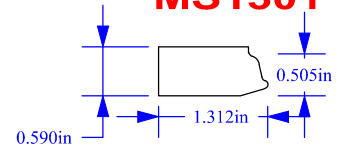

MS1270

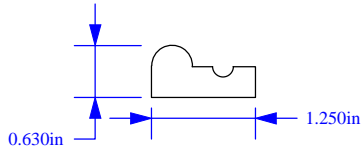

MS1284

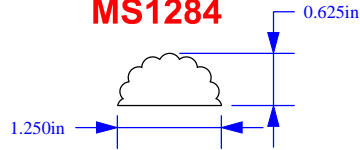

MS1271

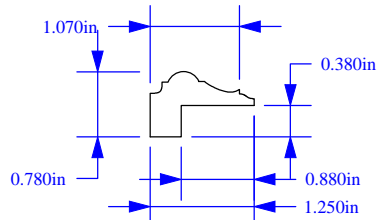

MS1285

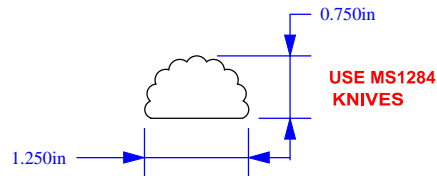

MS1272

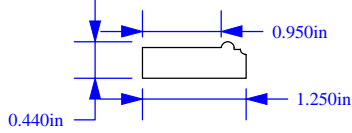

MS1286

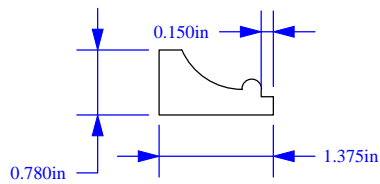

MS1274

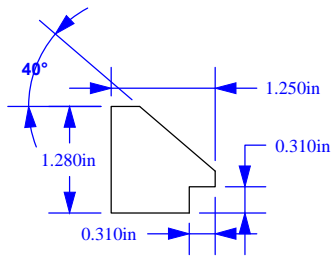

MS1287

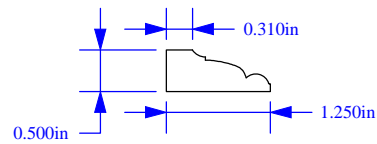

MS1278

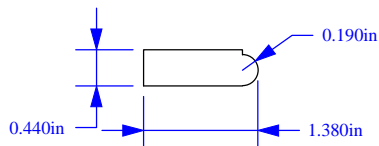

MS1288

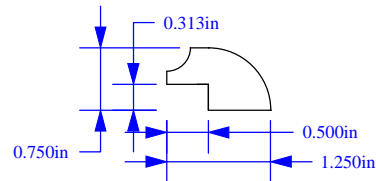

MS1279

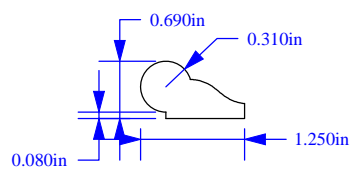

MS1289

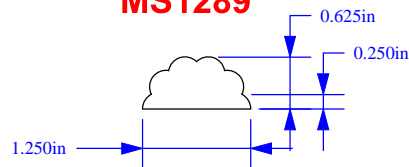

MS1281

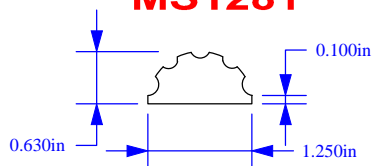

MS1290

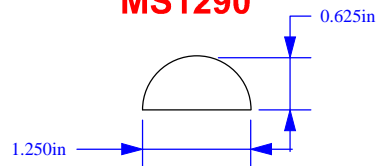

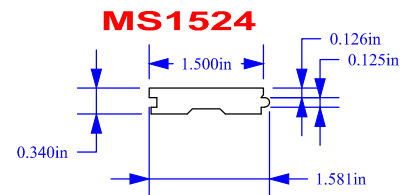
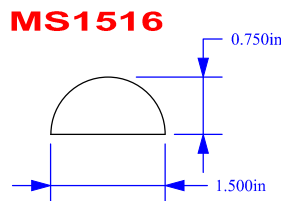
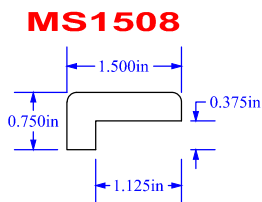
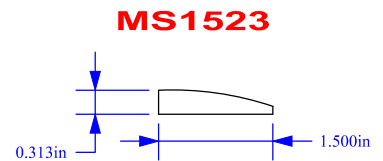
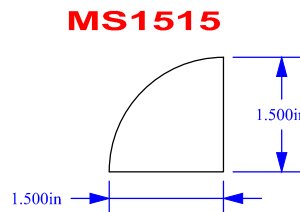
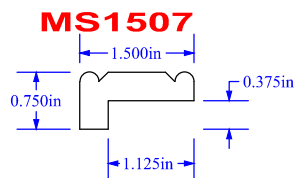
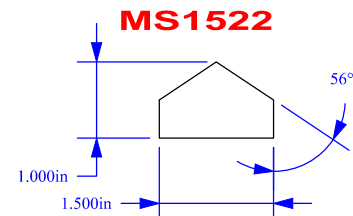
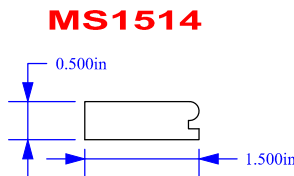
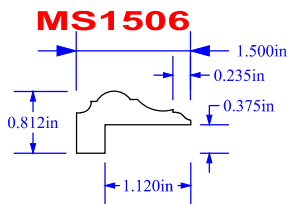
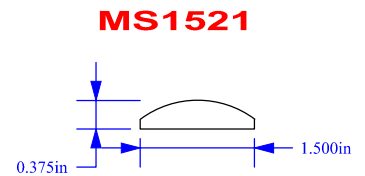
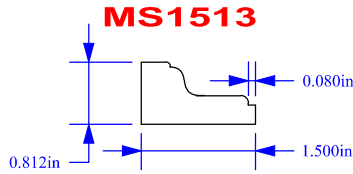
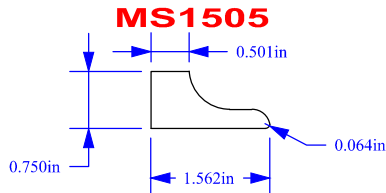
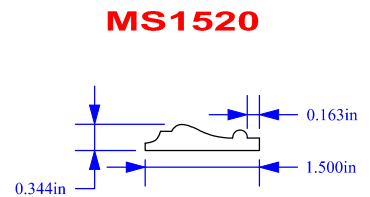
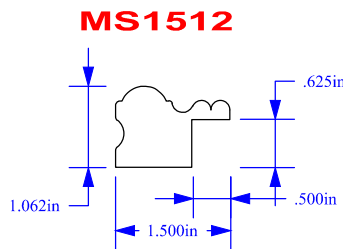
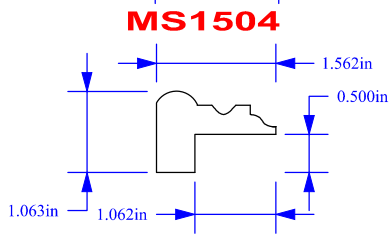
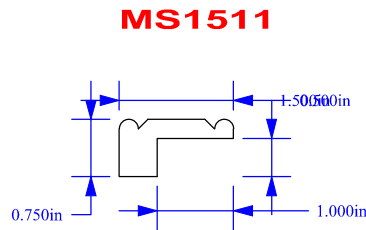
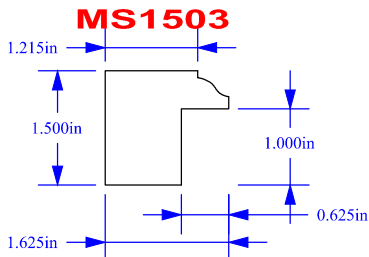
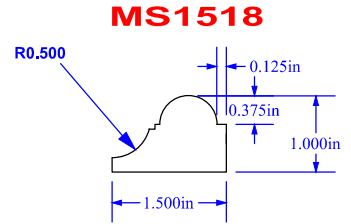
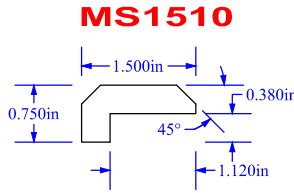
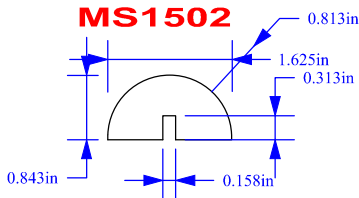
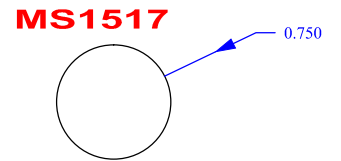
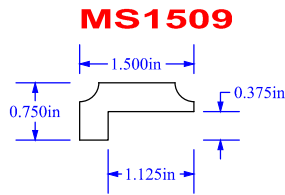
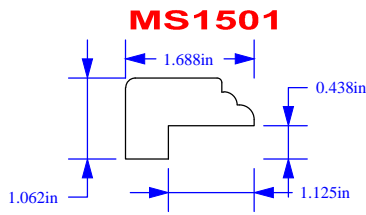

MS1525

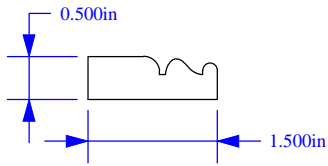

MS1533

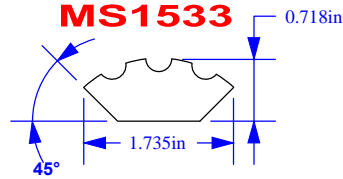

MS1541

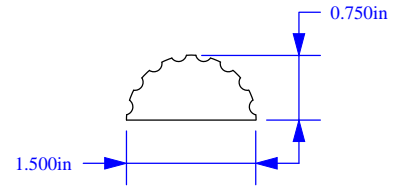

MS1526

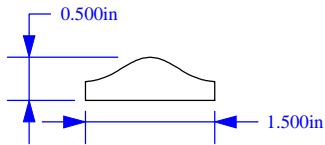

MS1534

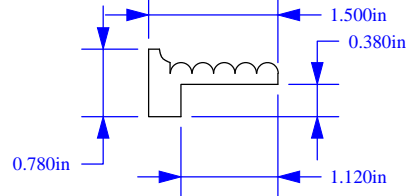

MS1542

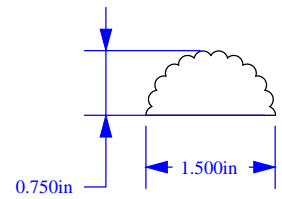

MS1527

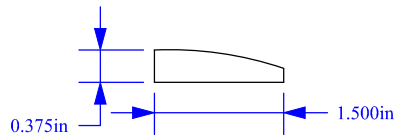

MS1535

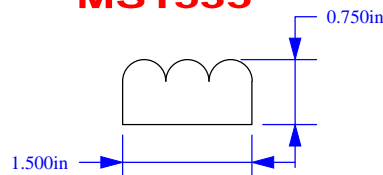

MS1543

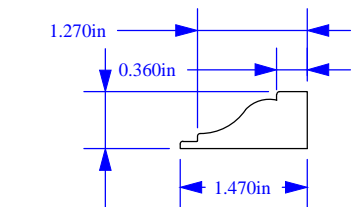

MS1529

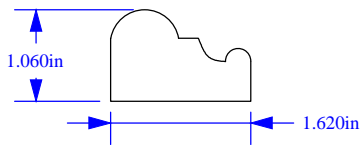

MS1537

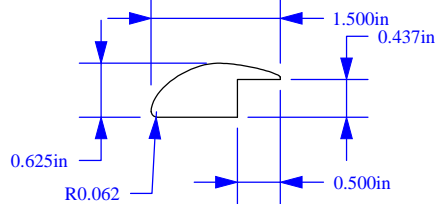

MS1544

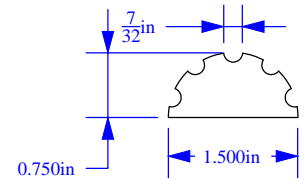

MS1530

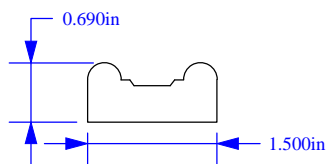

MS1538

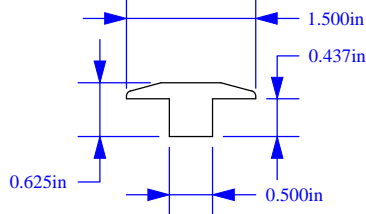

MS1545

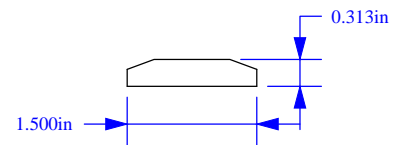

MS1531

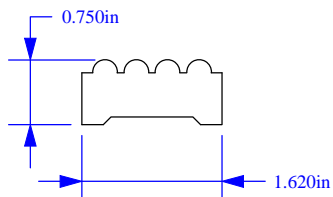

MS1539

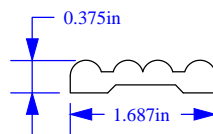

MS1546

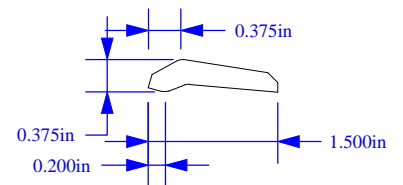

MS1532

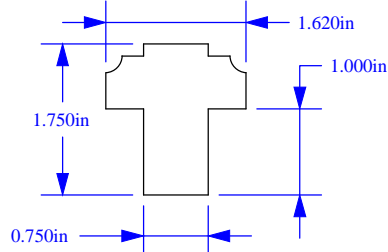

MS1540

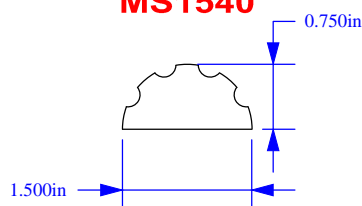

MS1547

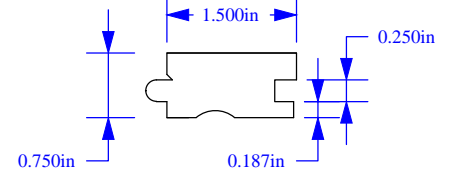

MS1620

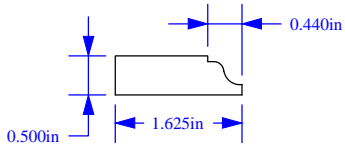

MS1755

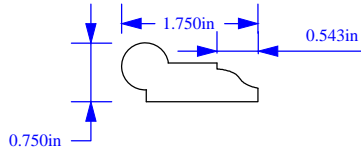

MS1762

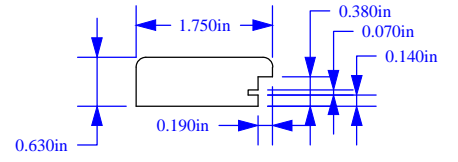

MS1621

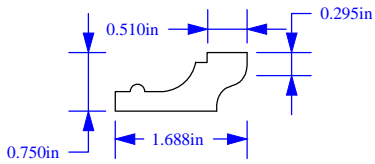

MS1756

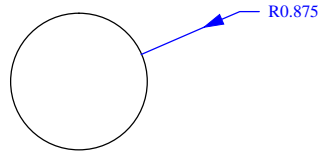

MS1763

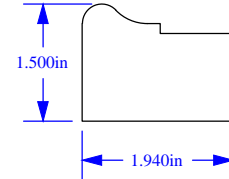

MS1750

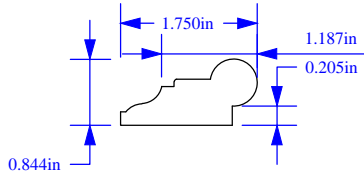

MS1757

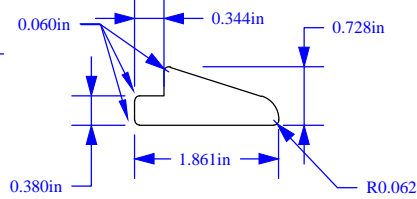

MS1764

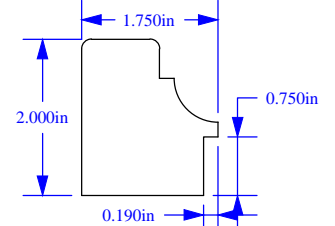

MS1751

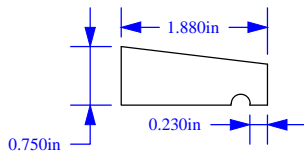

MS1758

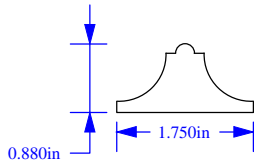

MS1765

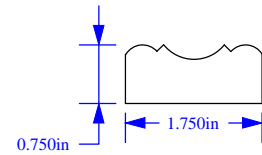

MS1752

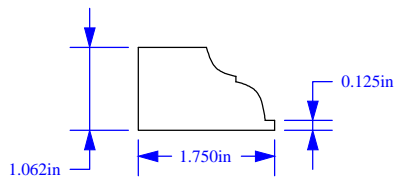

MS1759

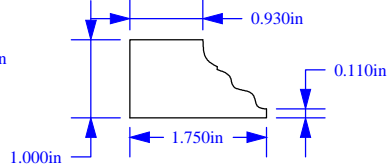

MS1753

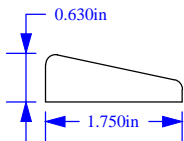

MS1760

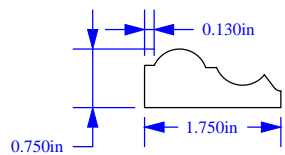

MS1754

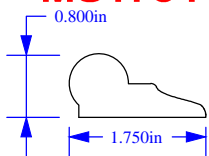

MS1761

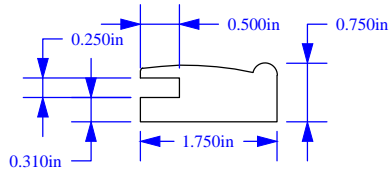

MS2001

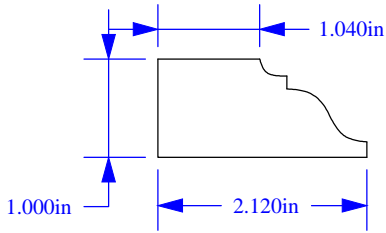

MS2008

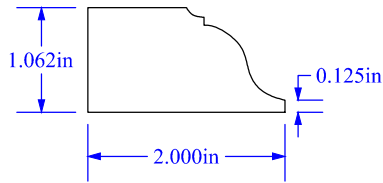

MS2014

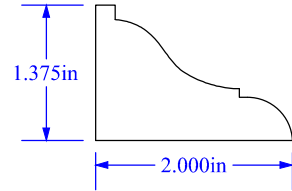

MS2002

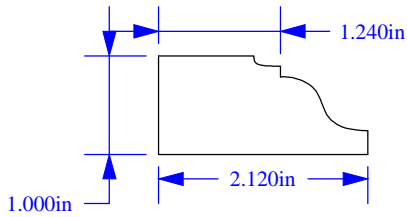

MS2009

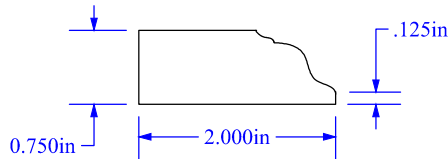

MS2015

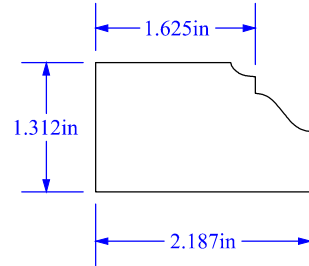

MS2003

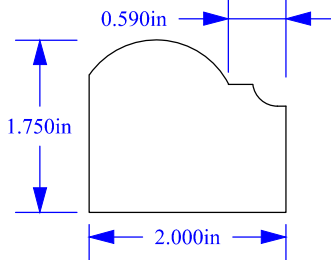

MS2010

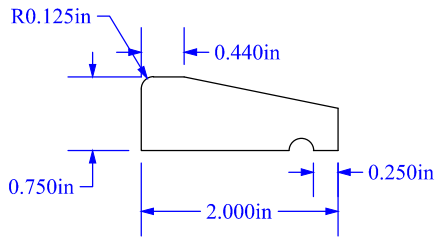

MS2016

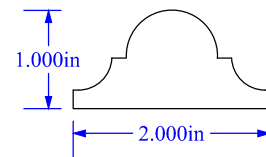

MS2004

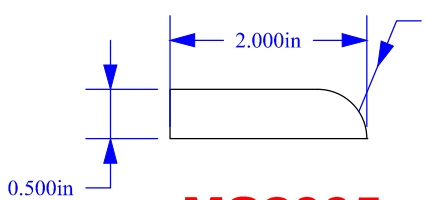

MS2011

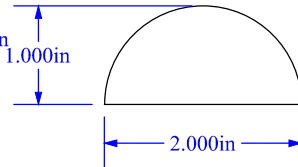

MS2019

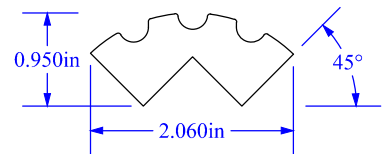

MS2005

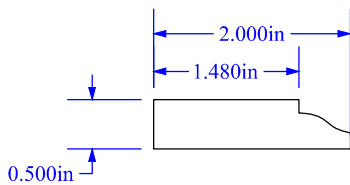

MS2012

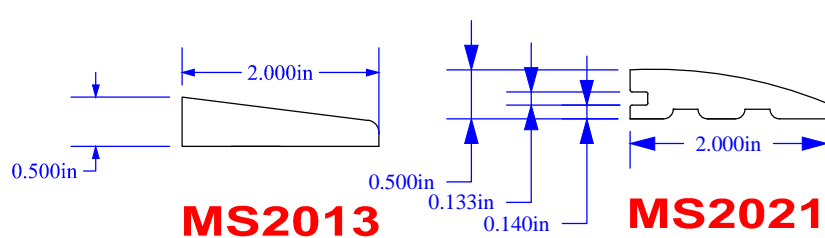

MS2020

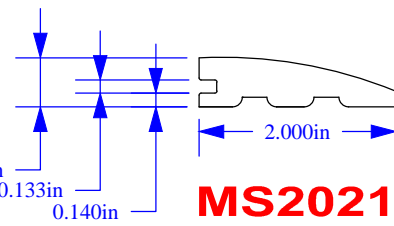

MS2006

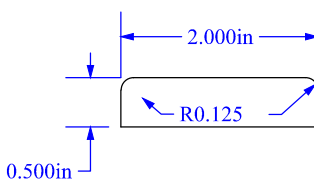

MS2013

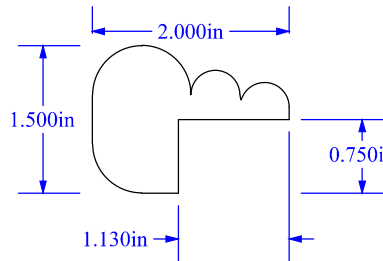

MS2021

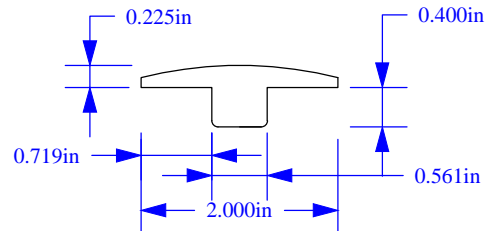

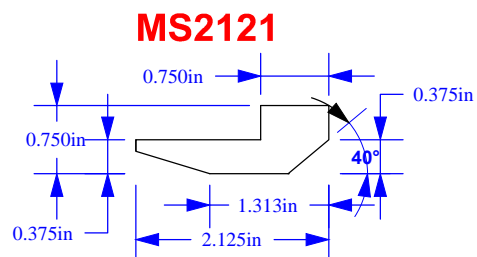
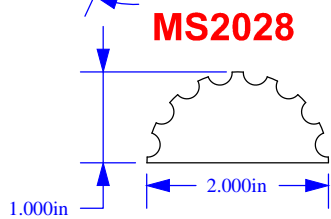
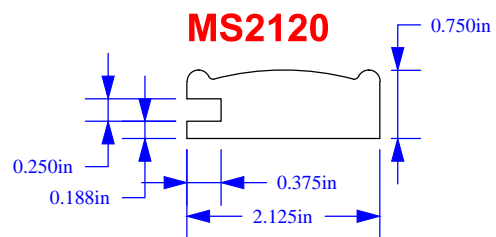
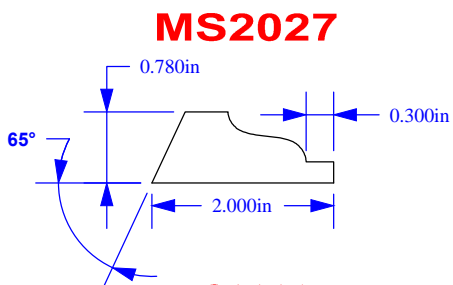
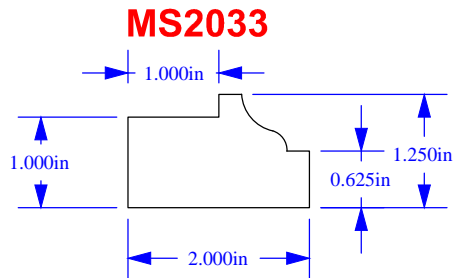
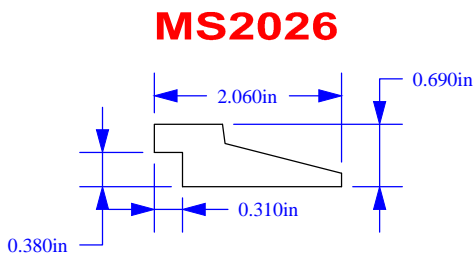
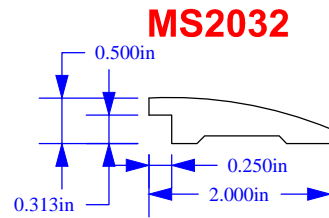
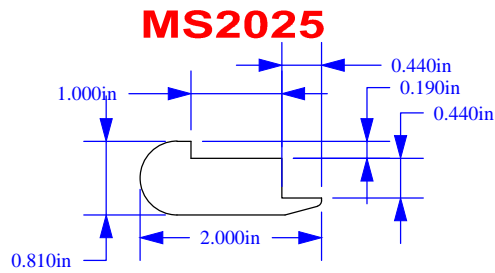
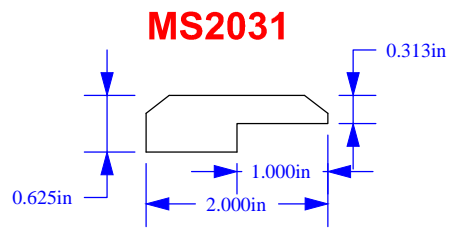
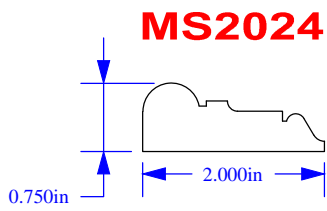
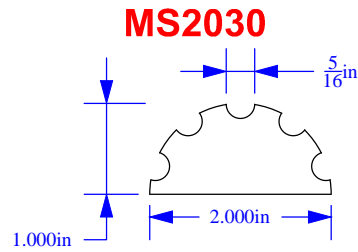
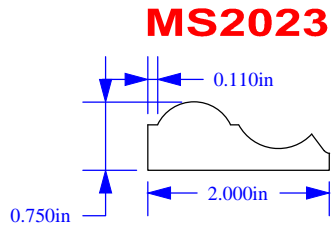
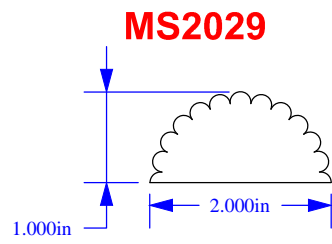
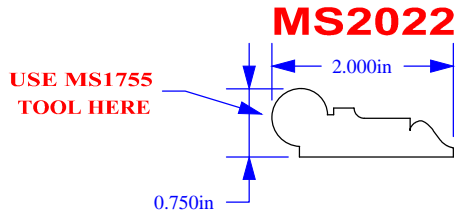

MS2252

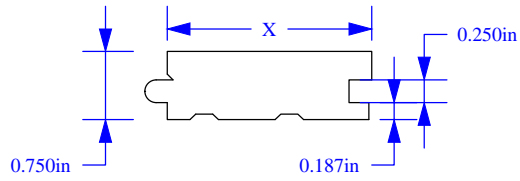

MS2253

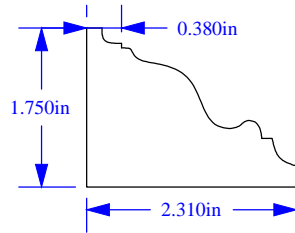

MS2254

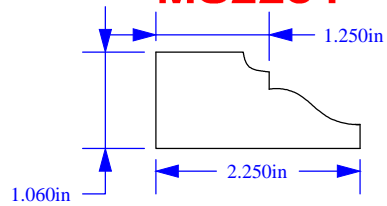

MS2257

RUN .015" THICKER FOR SANDING

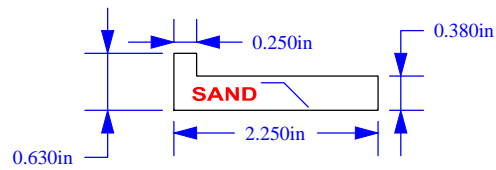

MS2258

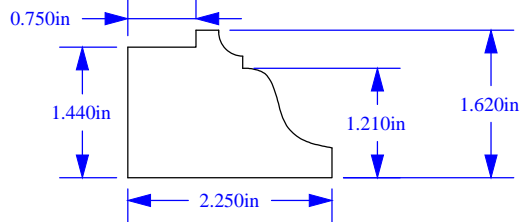

MS2259

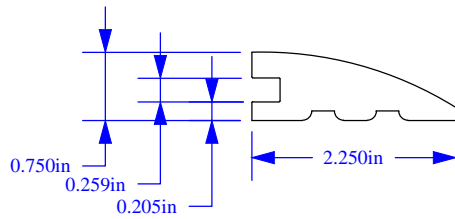

MS2300

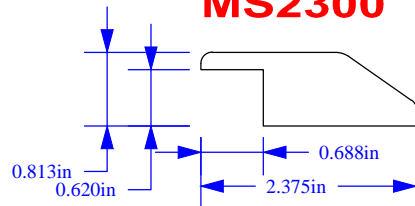

MS2501

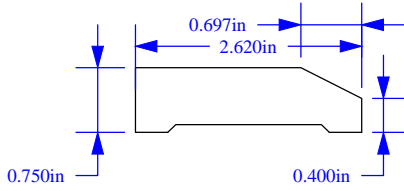

MS2509

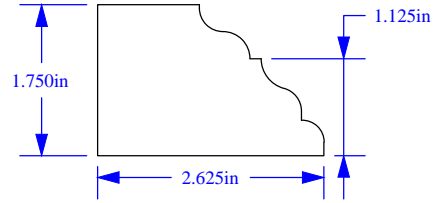

MS2502

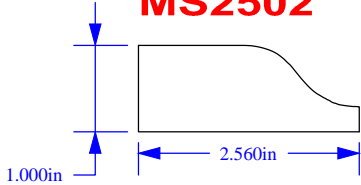

MS2510

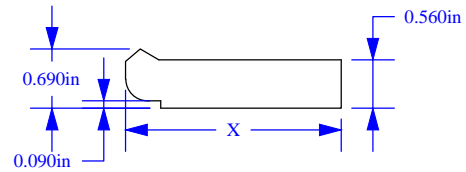

MS2503

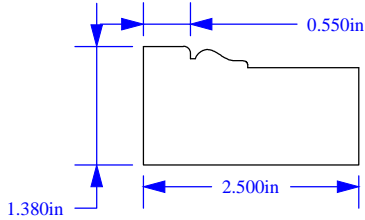

MS2511

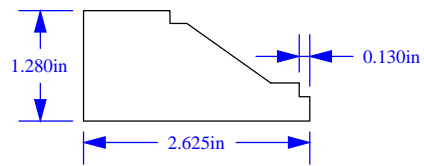

MS2504

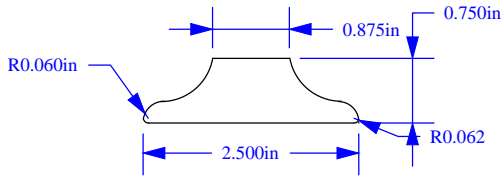

MS2512

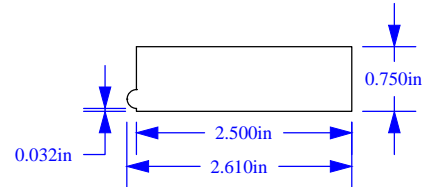

MS2505

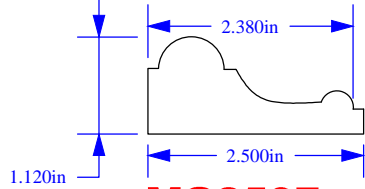

MS2513

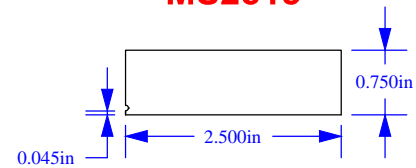

MS2507

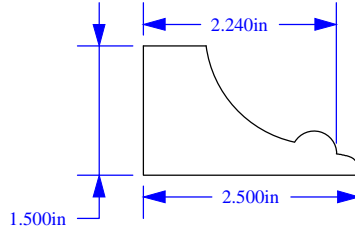

MS2513

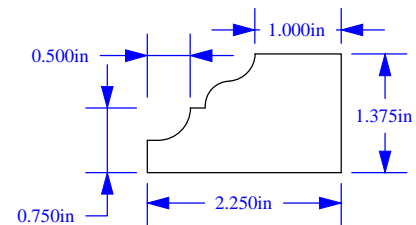

MS2508

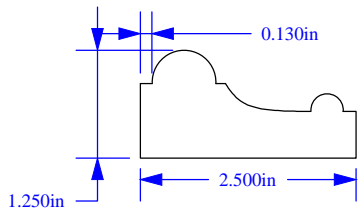

MS2751

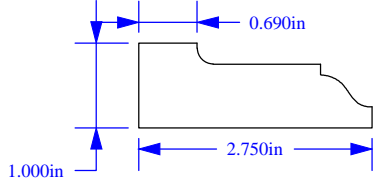

MS2758

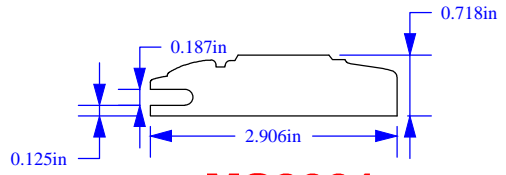

MS2752

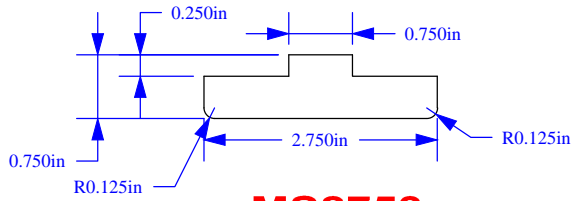

MS3001

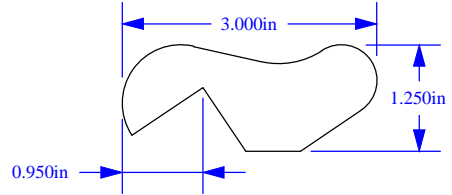

MS2753

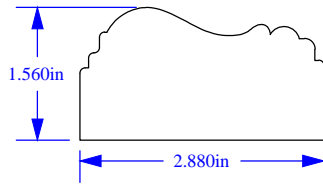

MS3003

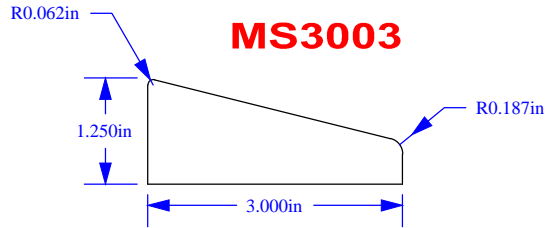

MS2754

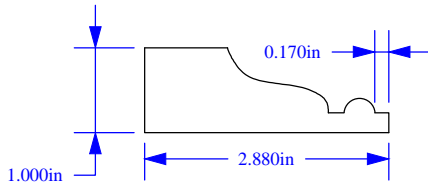

MS3004

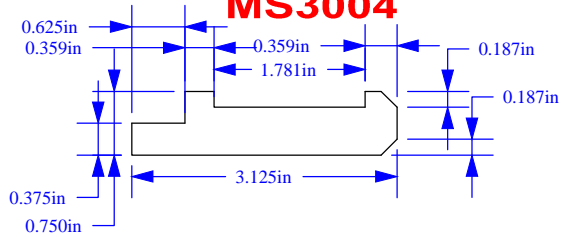

MS2755

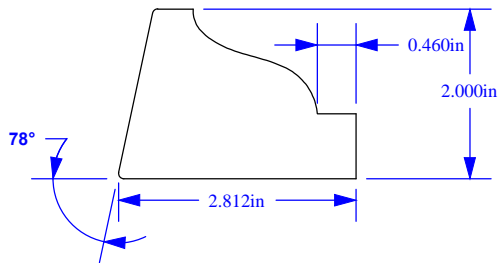

MS2756

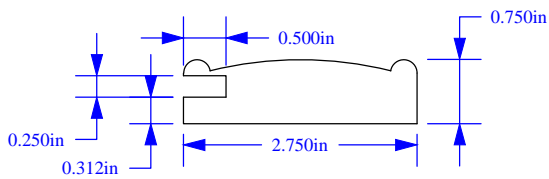

MS2757

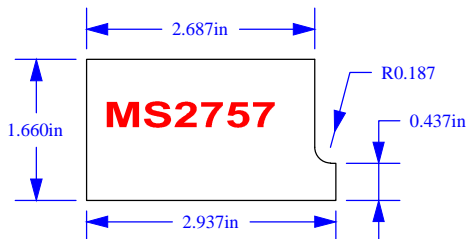

MS3501

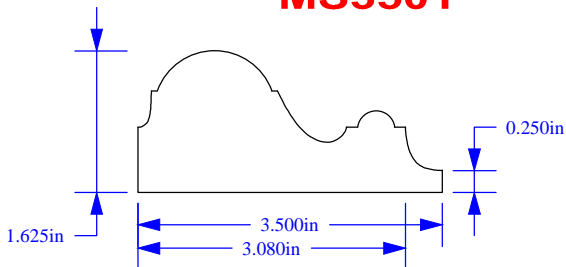

MS3508

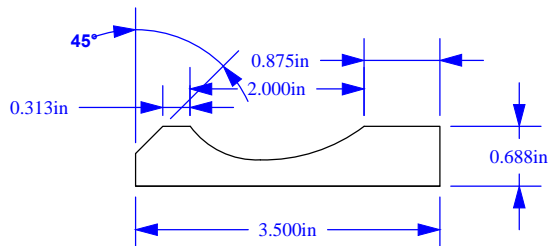

MS3502

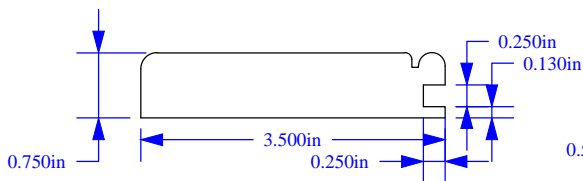

MS3509

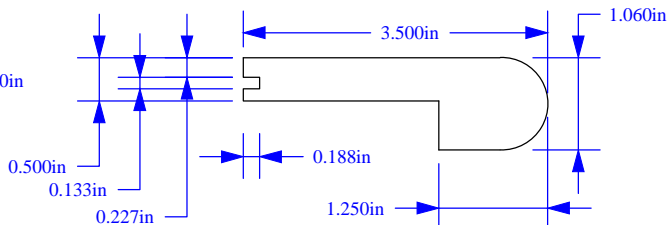

MS3503

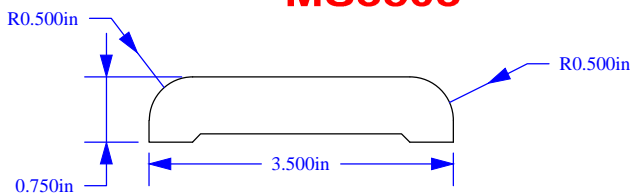

MS3510

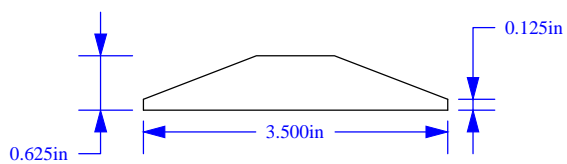

MS3504

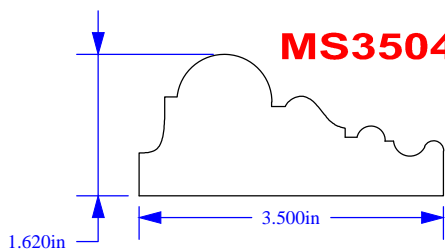

MS3751

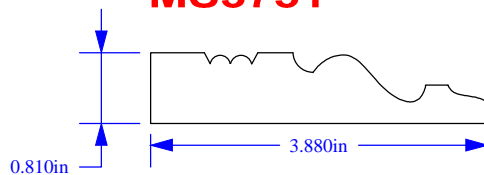

MS3505

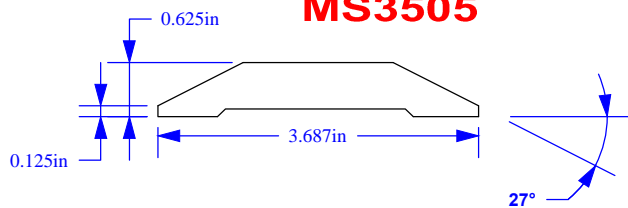

MS3752

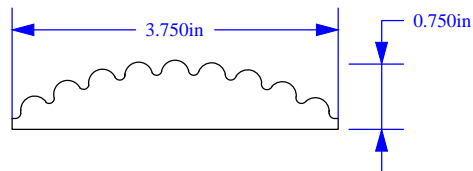

MS3506

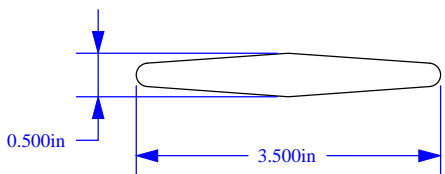

MS3753

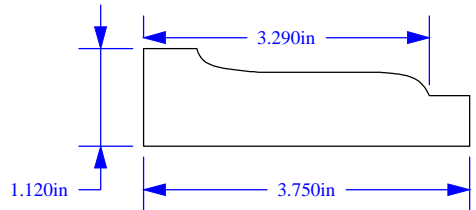

MS3507

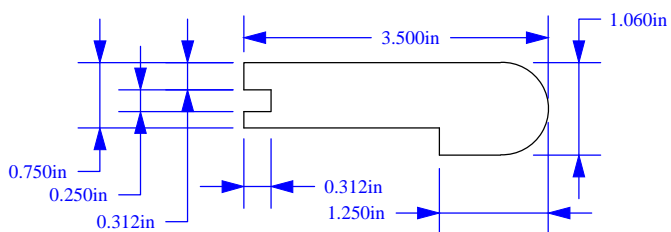

MS3754

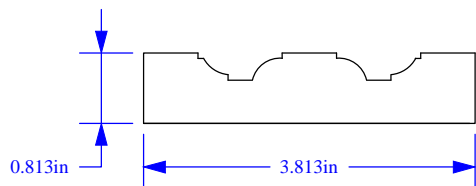

MS4002

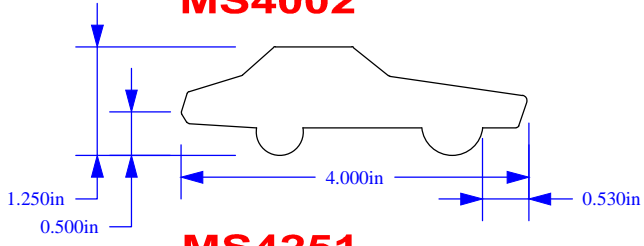

MS4251

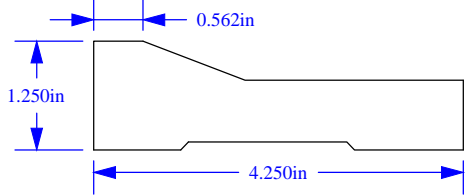

MS4252

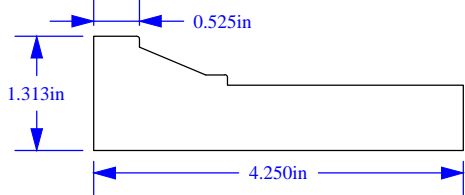

MS4501

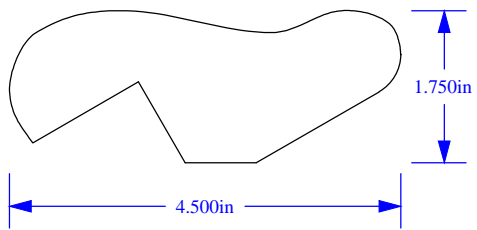

MS4502

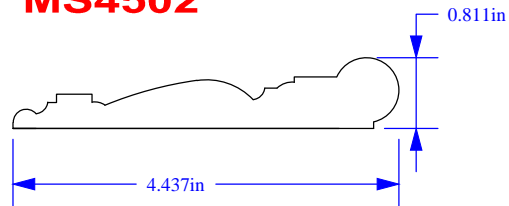

MS5000

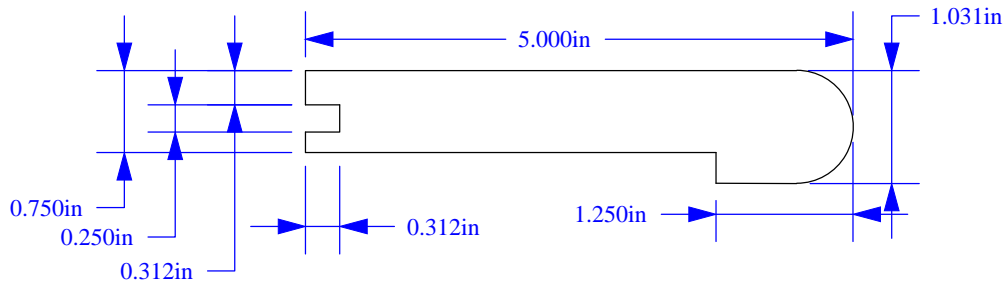

MS5251

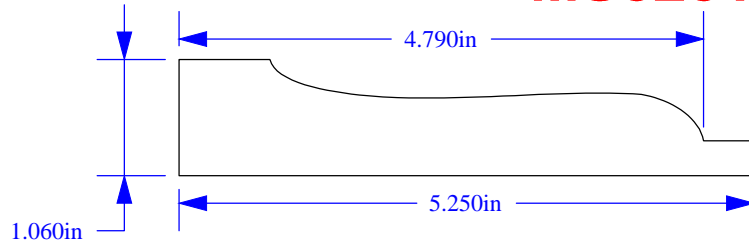

MS5252

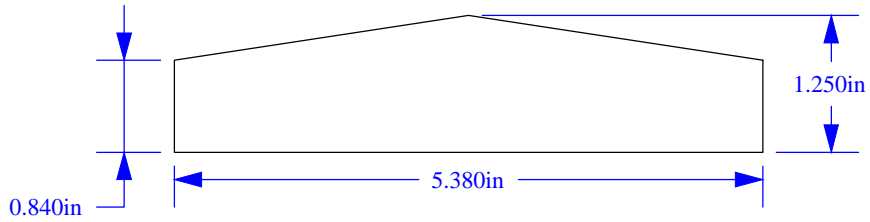

MS5253

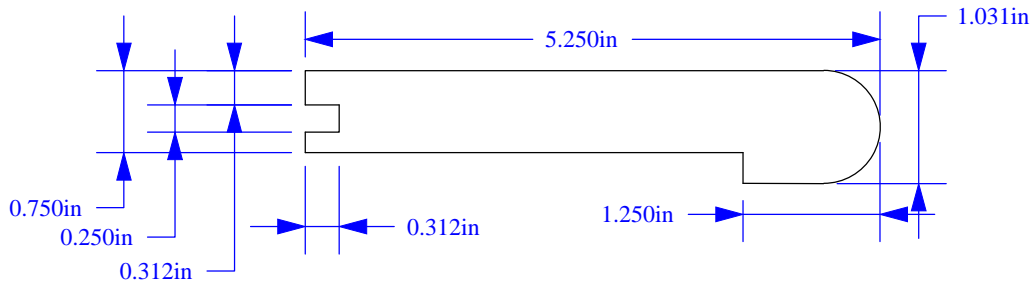

MS5501

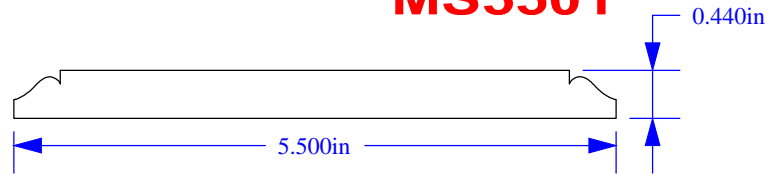

MS5503

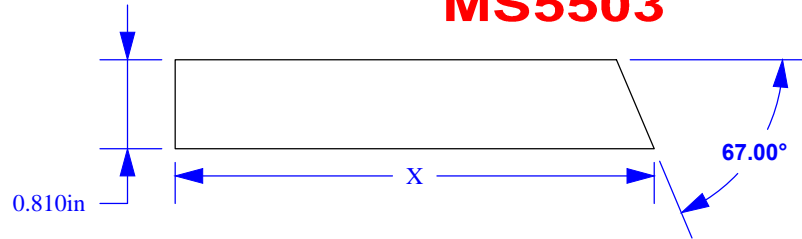

MS5504

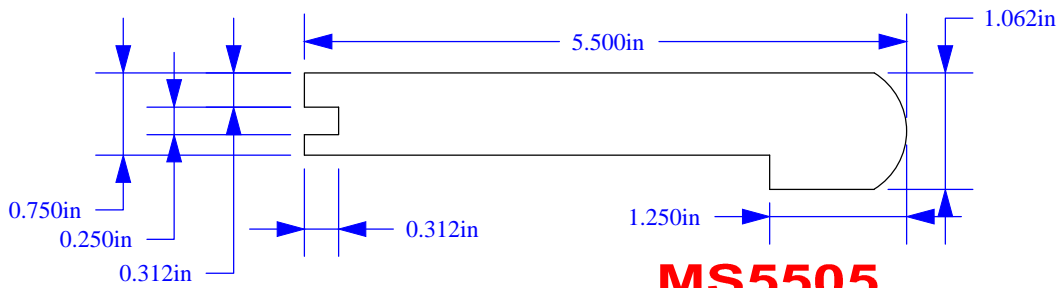

MS5505

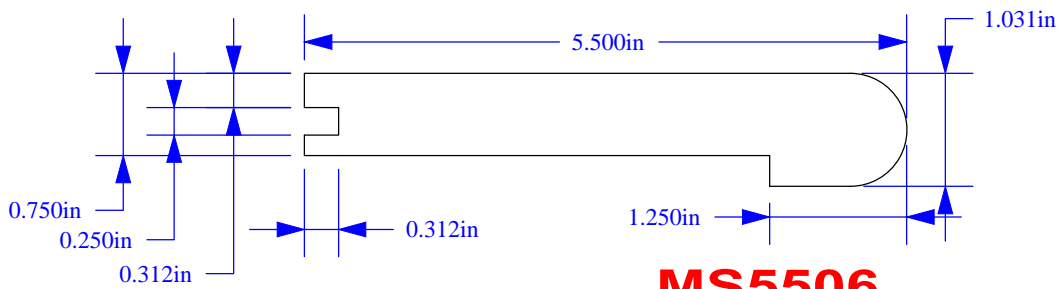

MS5506

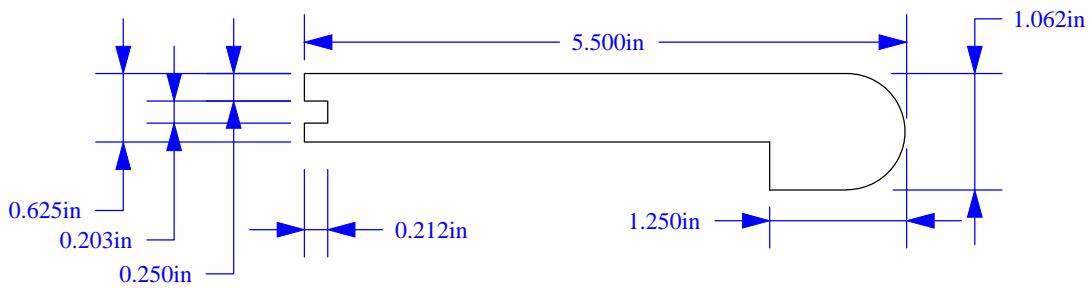

MS6001

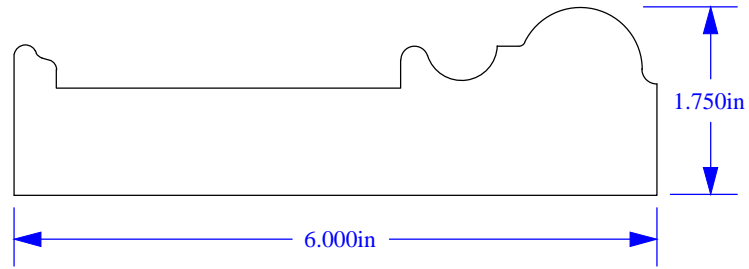

MS6002

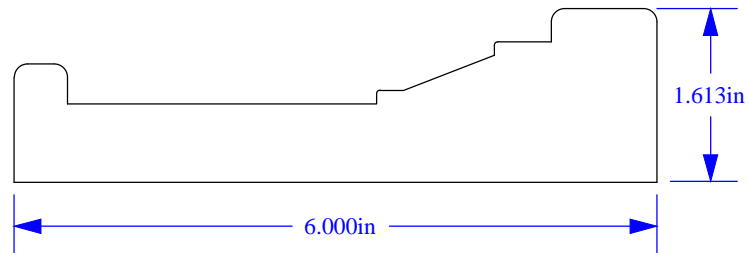

MS6251

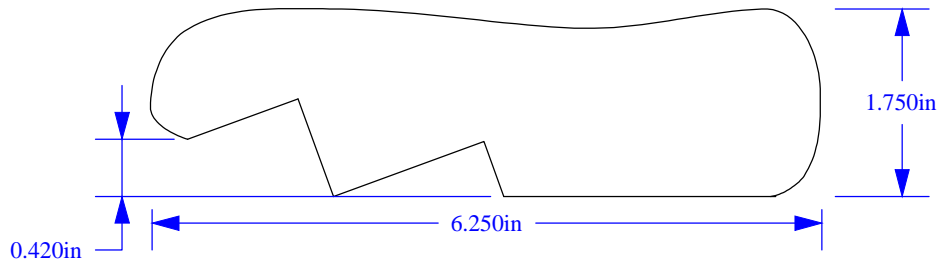

MS6502

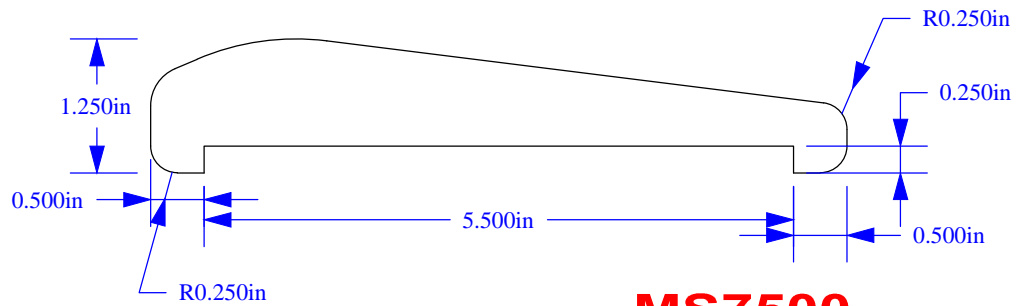

MS7500

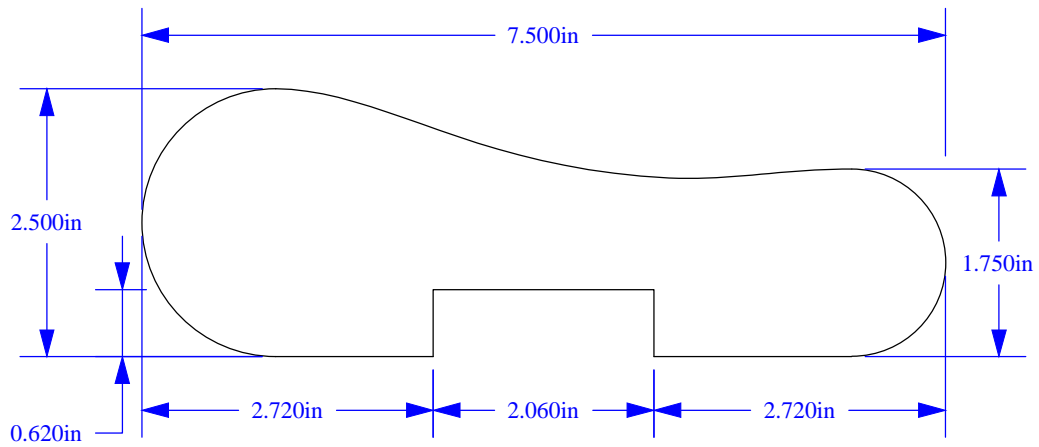

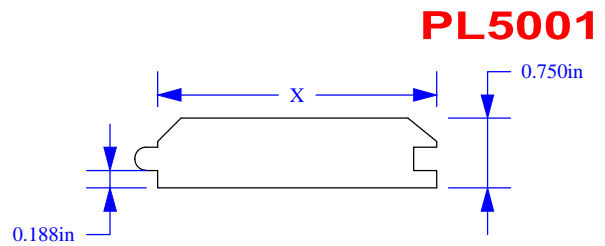
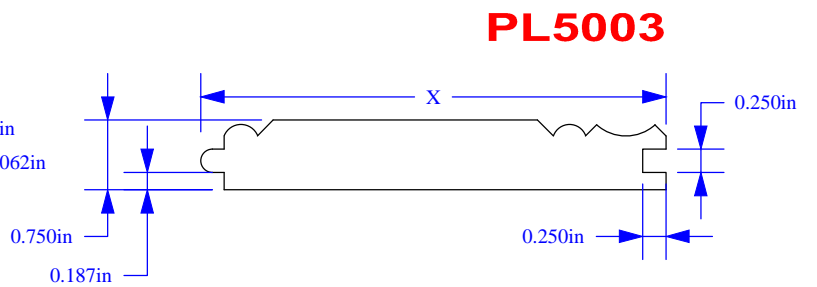
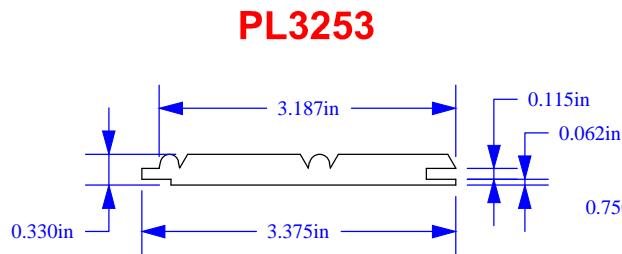
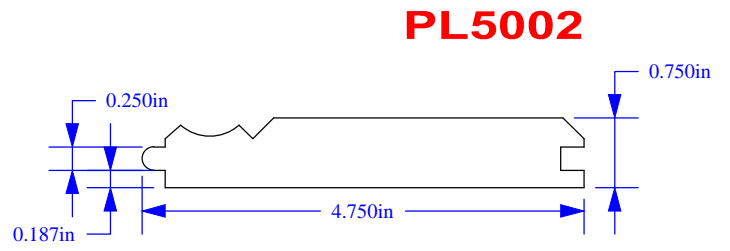
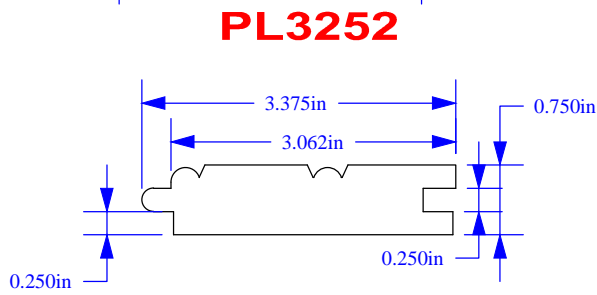
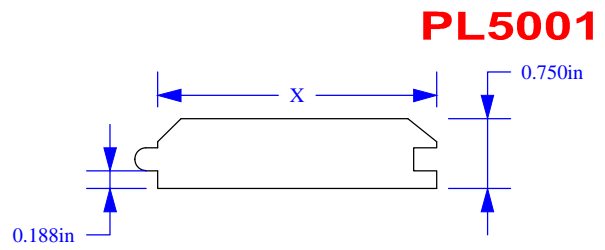
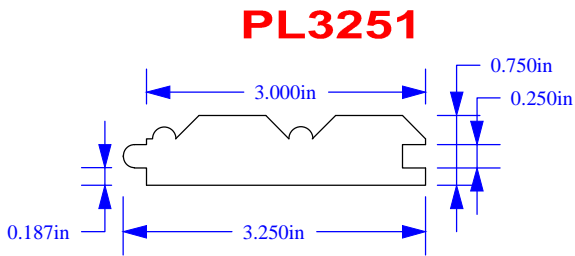
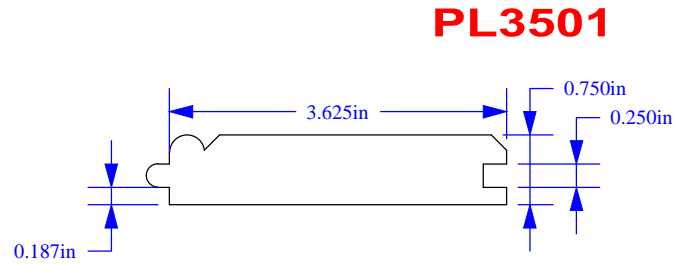
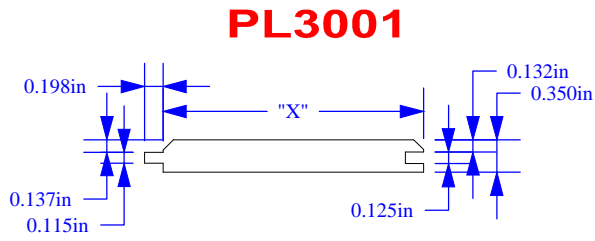
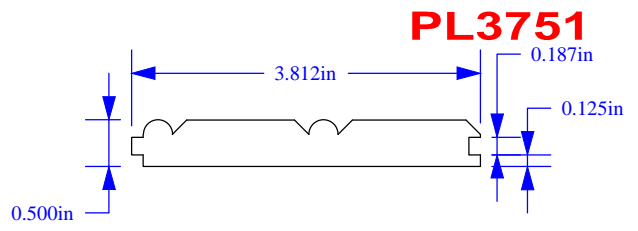
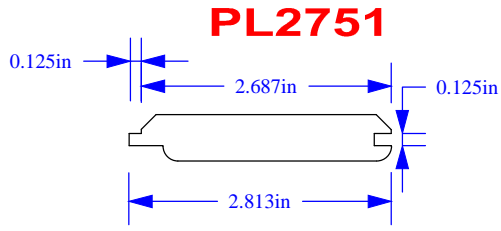

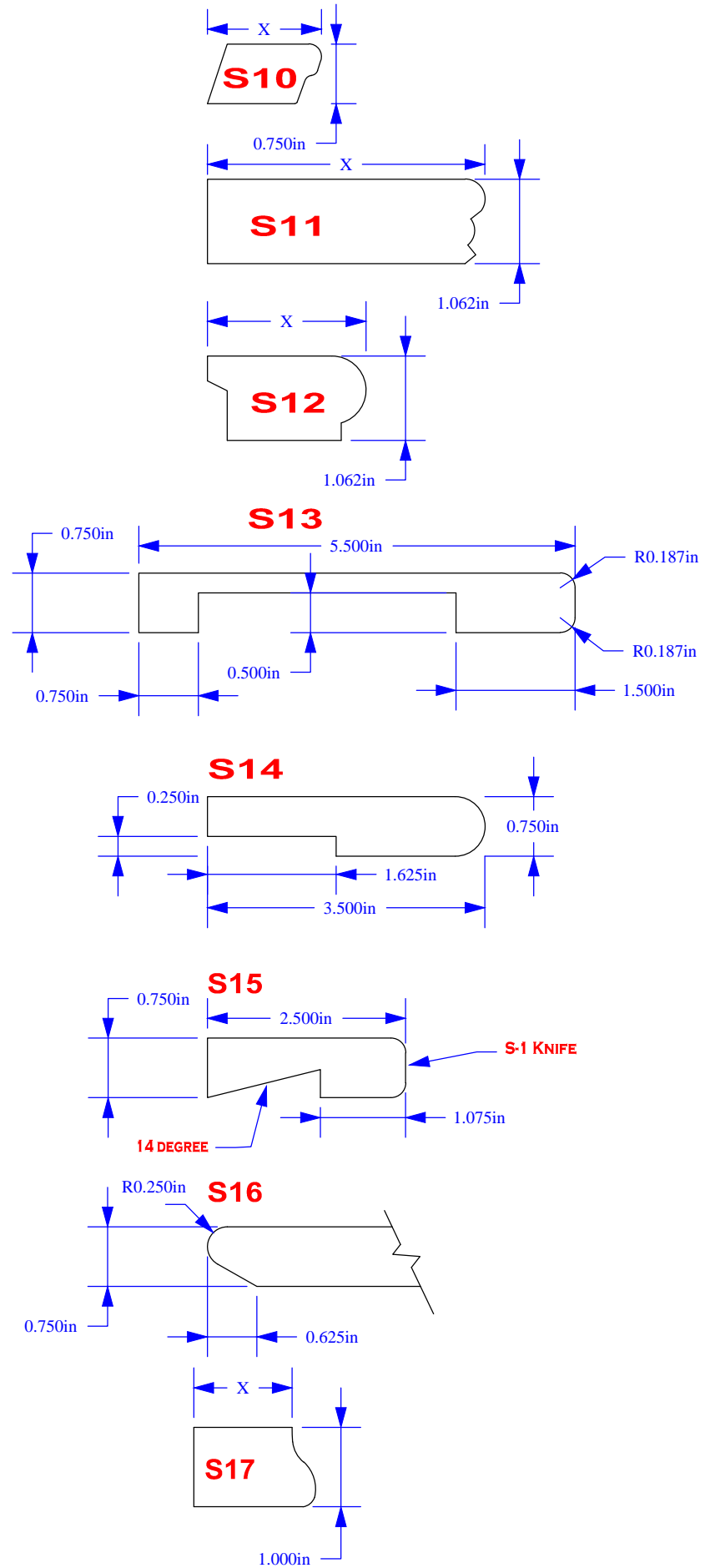
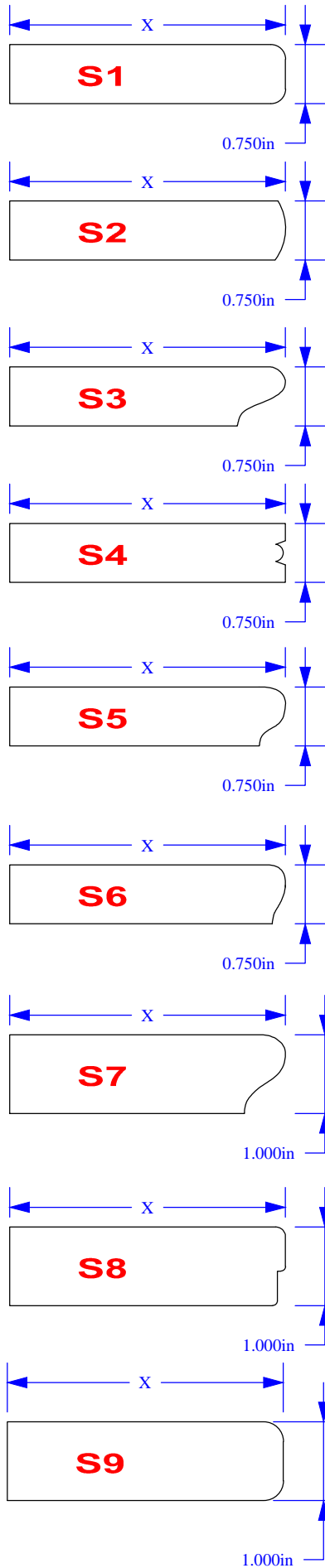

TRANSITIONAL MOLDINGS

Shoe Molding

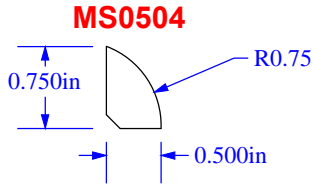

Quarter Round

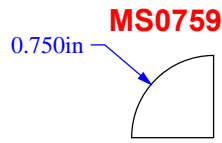

Cove

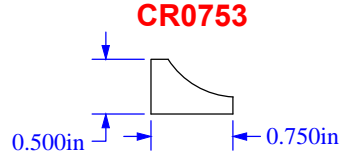

Mini Threshold

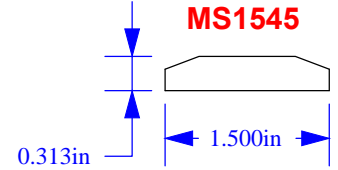

5/16" Reducer

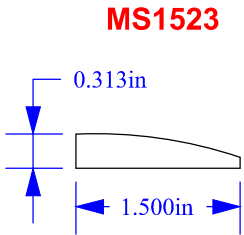

3/8" Reducer

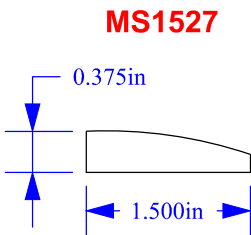

Small Binder

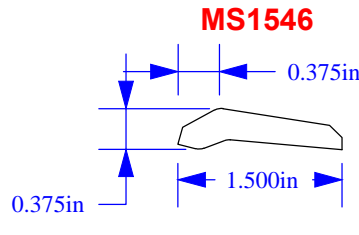

T-Molding

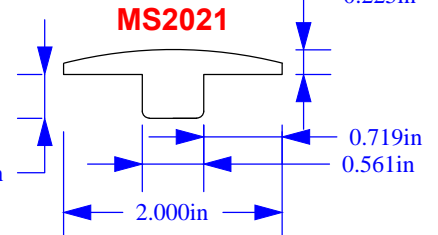

Mini-Reducer

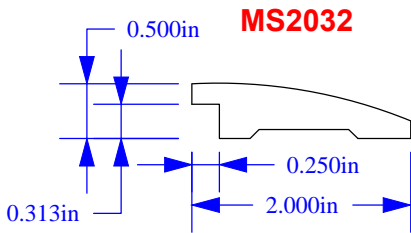

1/2" Reducer

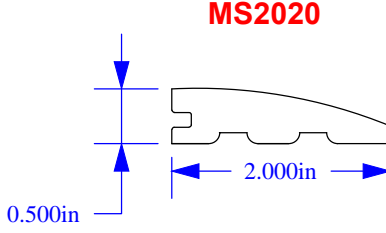

3/4" Reducer

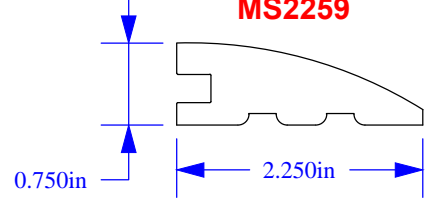

Feature strip

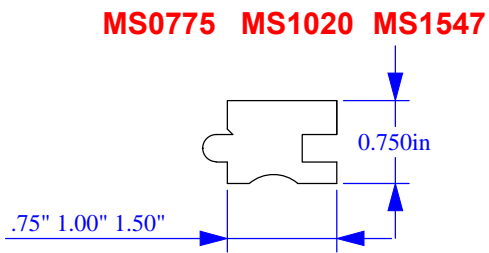

Square Nose Reducer

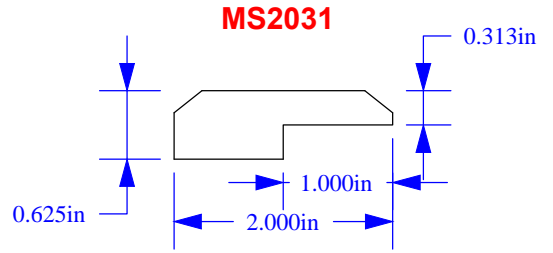

Nosing

